

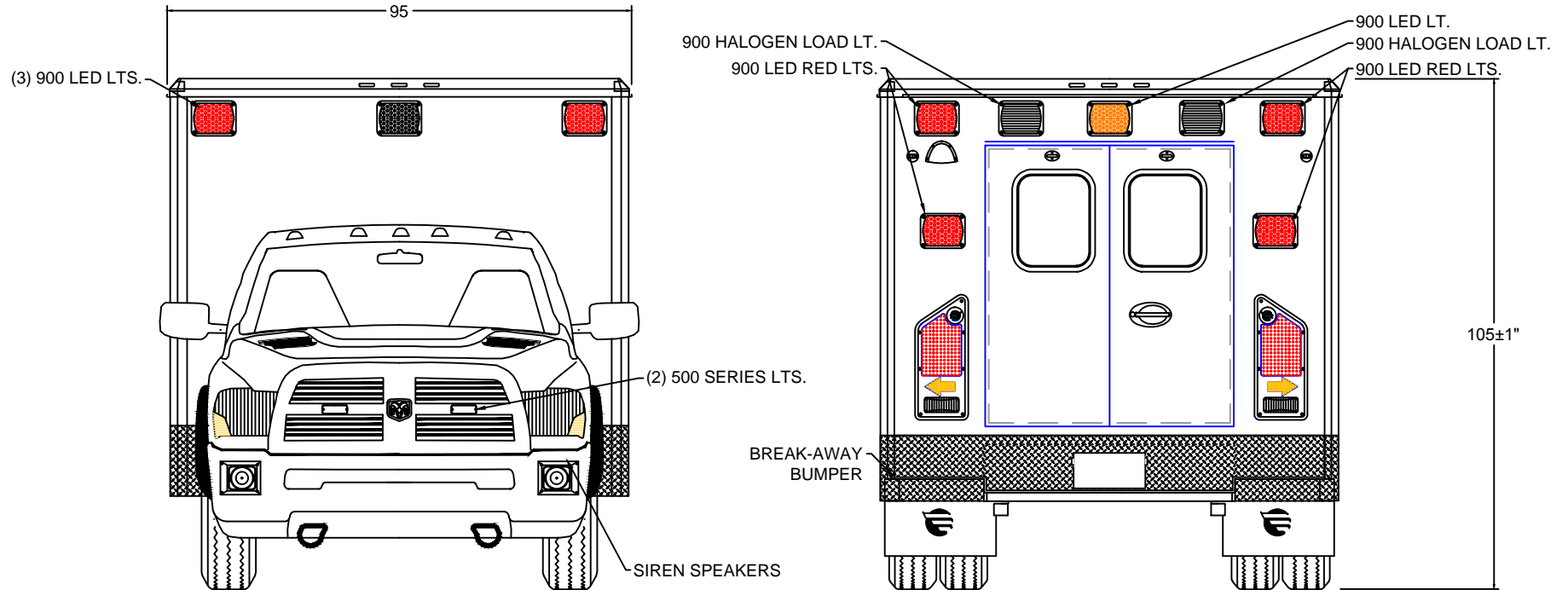

CA101270

MODEL 1153D

153 x 95 x 67



EXTERIOR COMPARTMENT DIMENSIONS IN INCHES													
INTERIOR DIMENSIONS				PASS THRU		INTERIOR DIMENSIONS				JAMB OPENING			
COMPT.	HEIGHT	WIDTH	DEPTH	HEIGHT	WIDTH	COMPT.	HEIGHT	WIDTH	DEPTH	HEIGHT	WIDTH		
													TYPE 1 DODGE 2018 FRONT / REAR EXTERIOR VIEWS
							BE ADVISED THAT THESE ARE PRELIMINARY LAYOUTS INTENDED TO ILLUSTRATE DESIGN INTENT AND DIMENSIONS ARE FOR REFERENCE ONLY PRIOR TO FINAL ENGINEERING					DATE: 02/05/18 DWN BY: SG	SCALE: DWG NO: 1 / 9

CA101270

MODEL 1153D

153 x 95 x 67

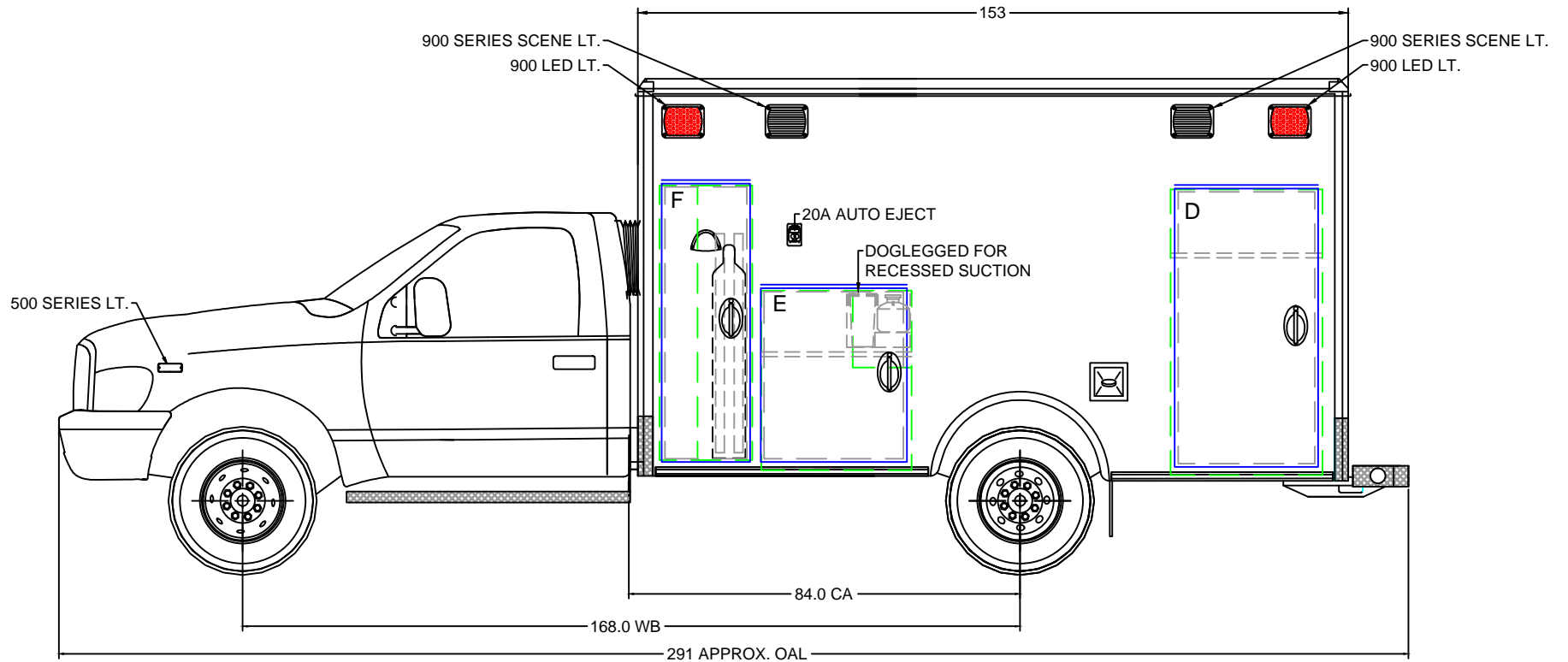

BE ADVISED THAT THESE ARE PRELIMINARY LAYOUTS INTENDED TO ILLUSTRATE DESIGN INTENT AND DIMENSIONS ARE FOR REFERENCE ONLY PRIOR TO FINAL ENGINEERING

EXTERIOR COMPARTMENT DIMENSIONS IN INCHES

INTERIOR DIMENSIONS				JAMB OPENING		INTERIOR DIMENSIONS				JAMB OPENING	
COMPT.	HEIGHT	WIDTH	DEPTH	HEIGHT	WIDTH	COMPT.	HEIGHT	WIDTH	DEPTH	HEIGHT	WIDTH
D	61.50	32.75	17.00	58.50	29.50						
E	38.75	32.25	17.00	37.00	30.00						
F	59.00	20.00	17.00	58.50	16.75						



TYPE 1 DODGE 2018

LEFT EXT. VIEW

DATE 02/05/18

SCALE

DRAWN BY SG

DWG NO

2 / 9

CA101270

MODEL 1153D

153 x 95 x 67

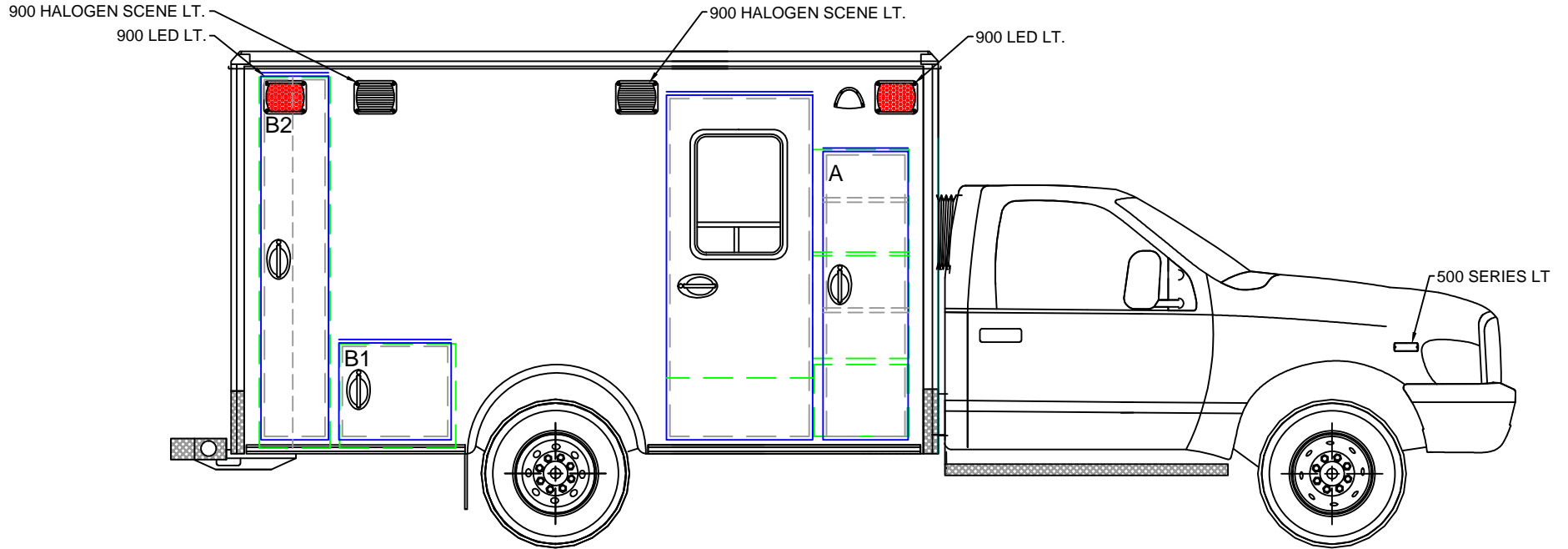

BE ADVISED THAT THESE ARE PRELIMINARY LAYOUTS INTENDED TO ILLUSTRATE DESIGN INTENT AND DIMENSIONS ARE FOR REFERENCE ONLY PRIOR TO FINAL ENGINEERING

EXTERIOR COMPARTMENT DIMENSIONS IN INCHES													
INTERIOR DIMENSIONS				JAMB OPENING		INTERIOR DIMENSIONS				JAMB OPENING			
COMPT.	HEIGHT	WIDTH	DEPTH	HEIGHT	WIDTH	COMPT.	HEIGHT	WIDTH	DEPTH	HEIGHT	WIDTH		
A	45.00	20.75	33.50	60.50	16.75								
LOWER-A	15.50	20.00	19.00										
B1	22.50	25.00	17.00	19.25	22.75								
B2	80.00	15.25	18.50	76.75	13.00								
											DATE	02/05/18	SCALE
											DRAWN BY	SG	DWG NO
													3 / 9

TYPE 1 DODGE 2018

RIGHT EXT. VIEW

CA101270

MODEL 1153D

153 x 95 x 67

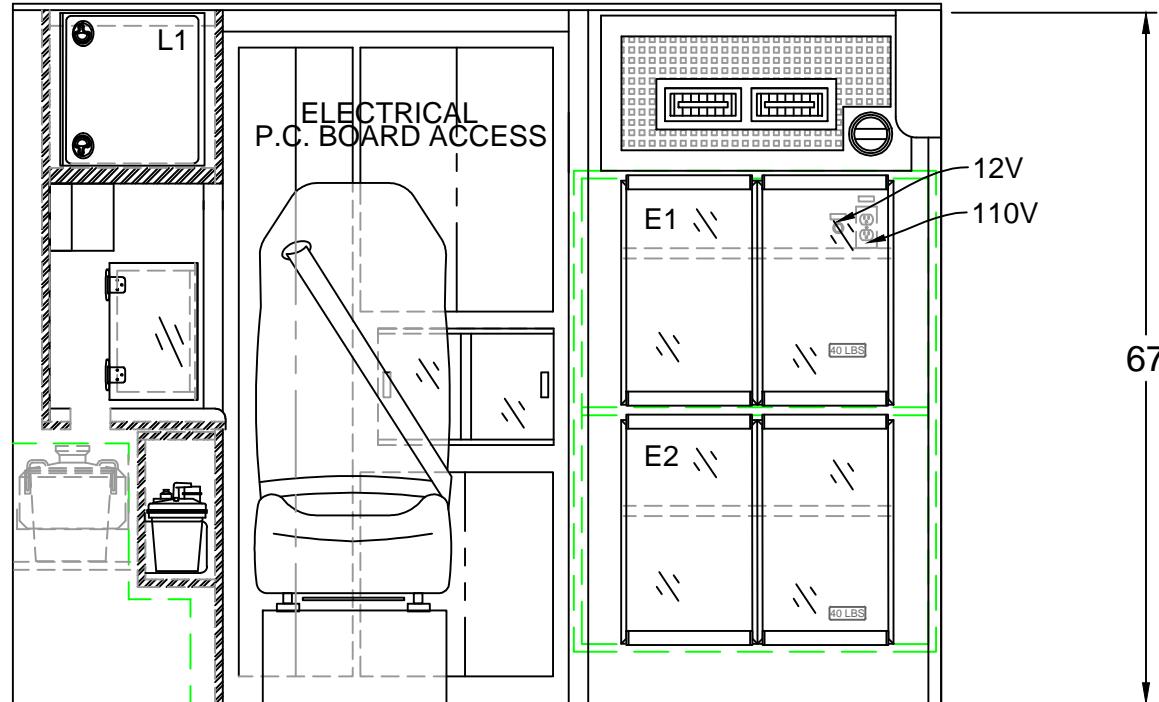

BE ADVISED THAT THESE ARE PRELIMINARY LAYOUTS INTENDED TO ILLUSTRATE DESIGN INTENT AND DIMENSIONS ARE FOR REFERENCE ONLY PRIOR TO FINAL ENGINEERING

CABINET WEIGHT RATINGS:
NON-RESTOCKING = 40 LBS.
RESTOCKING = 30 LBS.

INTERIOR CABINET DIMENSIONS IN INCHES

CABINET	HEIGHT	WIDTH	DEPTH	CABINET	HEIGHT	WIDTH	DEPTH
E1	22.00	33.50	20.75				
E2	22.00	33.50	20.75				



TYPE 1 DODGE 2018
BULKHEAD INTERIOR

DATE 02/05/18

SCALE

DRAWN BY SG

DWG NO 4 / 9

CA101270

MODEL 1153D

153 x 95 x 67

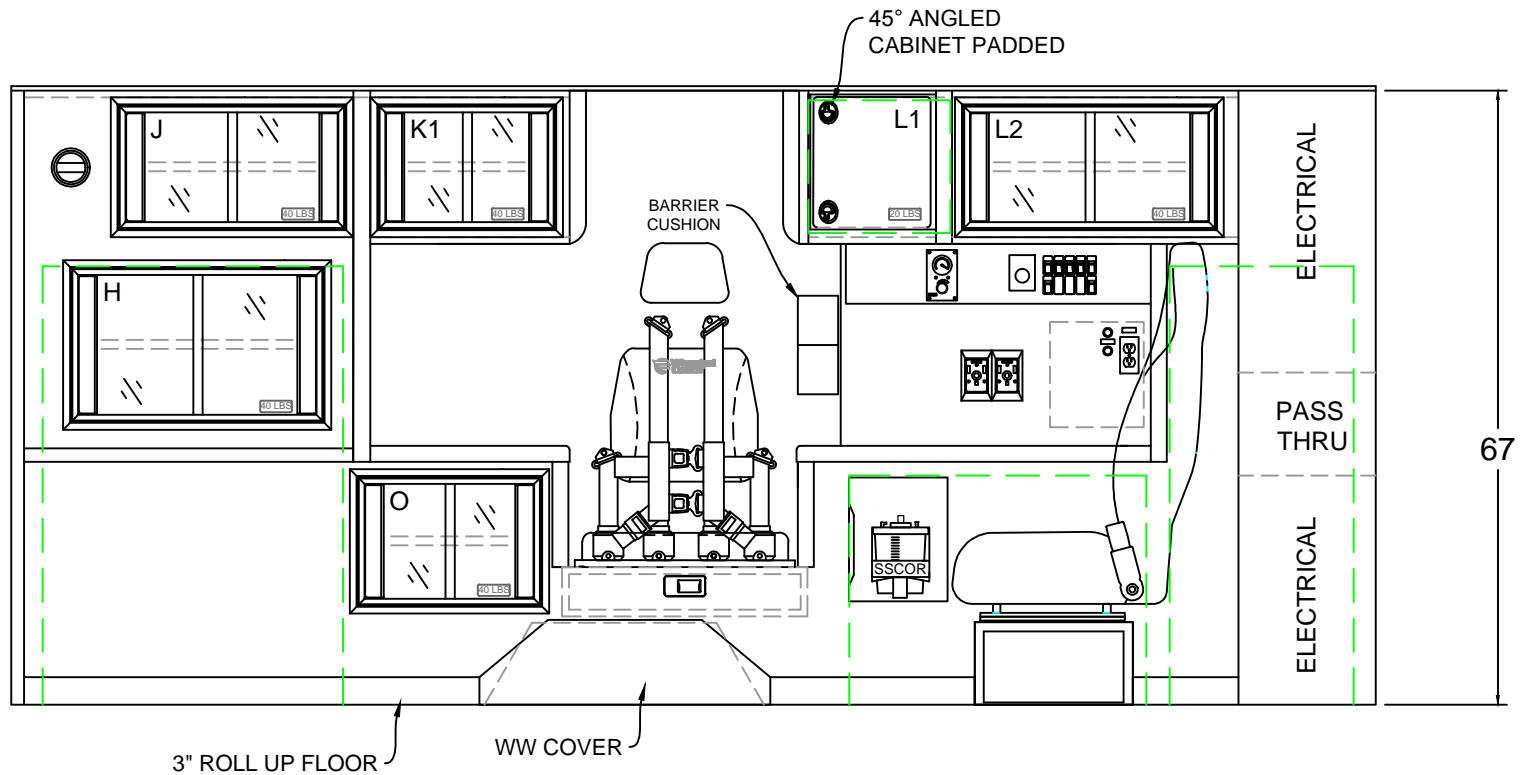

INTERIOR CABINET DIMENSIONS IN INCHES

CABINET	HEIGHT	WIDTH	DEPTH		CABINET	HEIGHT	WIDTH	DEPTH	
H	17.50	25.50	IS/OS		O	14.25	20.25	17.50	
J	13.75	25.00	17.50						
K1	13.75	19.25	12.00						
L1	13.25	10.00	15.25						
L2	13.75	27.75	15.25						

CABINET WEIGHT RATINGS:
 NON-RESTOCKING = 40 LBS.
 RESTOCKING = 30 LBS.

BE ADVISED THAT THESE ARE PRELIMINARY LAYOUTS INTENDED TO ILLUSTRATE DESIGN INTENT AND DIMENSIONS ARE FOR REFERENCE ONLY PRIOR TO FINAL ENGINEERING



TYPE 1 DODGE 2018

LEFT INTERIOR

DATE:	02/05/18	SCALE:	
DWG BY:	SG	DWG NO:	5 / 9

CA101270

MODEL 1153D

153 x 95 x 67

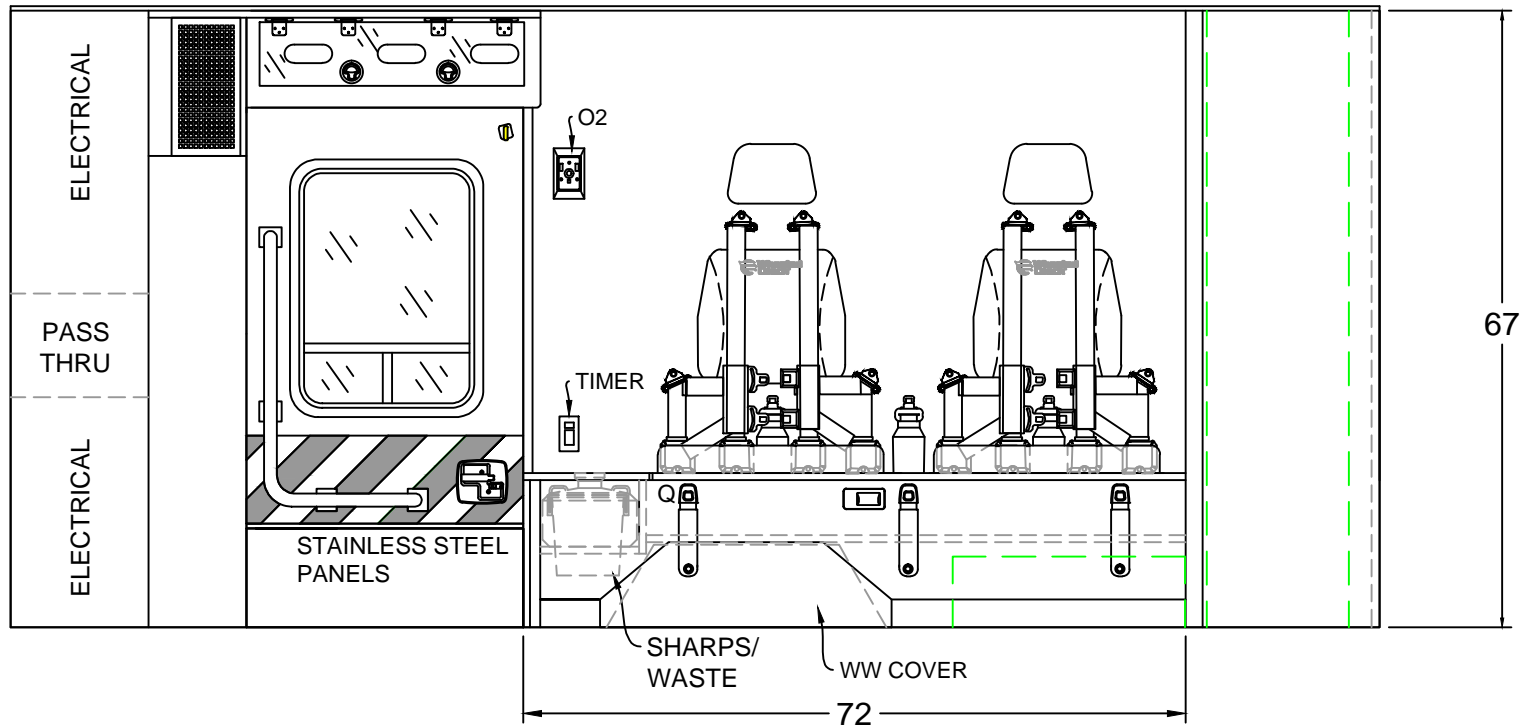

INTERIOR CABINET DIMENSIONS IN INCHES

COMPT.	HEIGHT	WIDTH	DEPTH		COMPT.	HEIGHT	WIDTH	DEPTH	
Q	7.25	59.75	16.75						

CABINET WEIGHT RATINGS:
 NON-RESTOCKING = 40 LBS.
 RESTOCKING = 30 LBS.

BE ADVISED THAT THESE ARE PRELIMINARY LAYOUTS INTENDED TO ILLUSTRATE DESIGN INTENT AND DIMENSIONS ARE FOR REFERENCE ONLY PRIOR TO FINAL ENGINEERING



TYPE 1 DODGE 2018
 RIGHT INTERIOR

DATE: 02/05/18

SCALE

OWN BY

SG

DWG NO

6 / 9

CA101270

MODEL 1153D

153 x 95 x 67

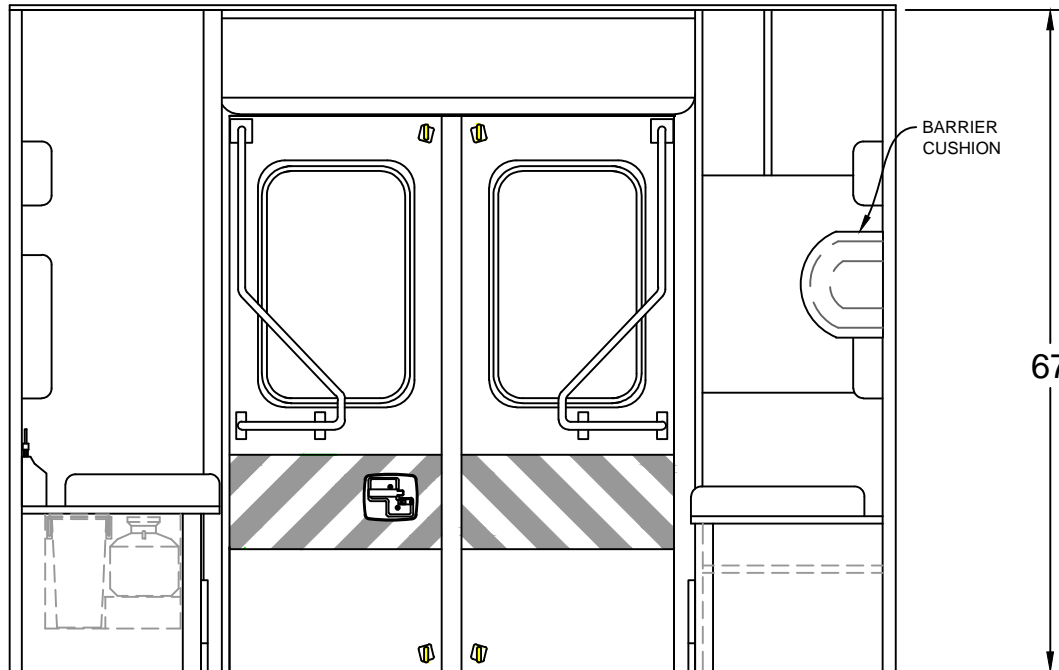

INTERIOR CABINET DIMENSIONS IN INCHES



TYPE 1 DODGE 2018

REAR BULKHEAD INTERIOR

COMPT.	HEIGHT	WIDTH	DEPTH	COMPT.	HEIGHT	WIDTH	DEPTH

DATE: 02/05/18

SCALE

DWN BY

SG

DWG NO

7 / 9

CABINET WEIGHT RATINGS:
NON-RESTOCKING = 40 LBS.
RESTOCKING = 30 LBS.

BE ADVISED THAT THESE ARE PRELIMINARY LAYOUTS INTENDED TO ILLUSTRATE DESIGN INTENT AND DIMENSIONS ARE FOR REFERENCE ONLY PRIOR TO FINAL ENGINEERING

CA101270

MODEL 1153D

153 x 95 x 67

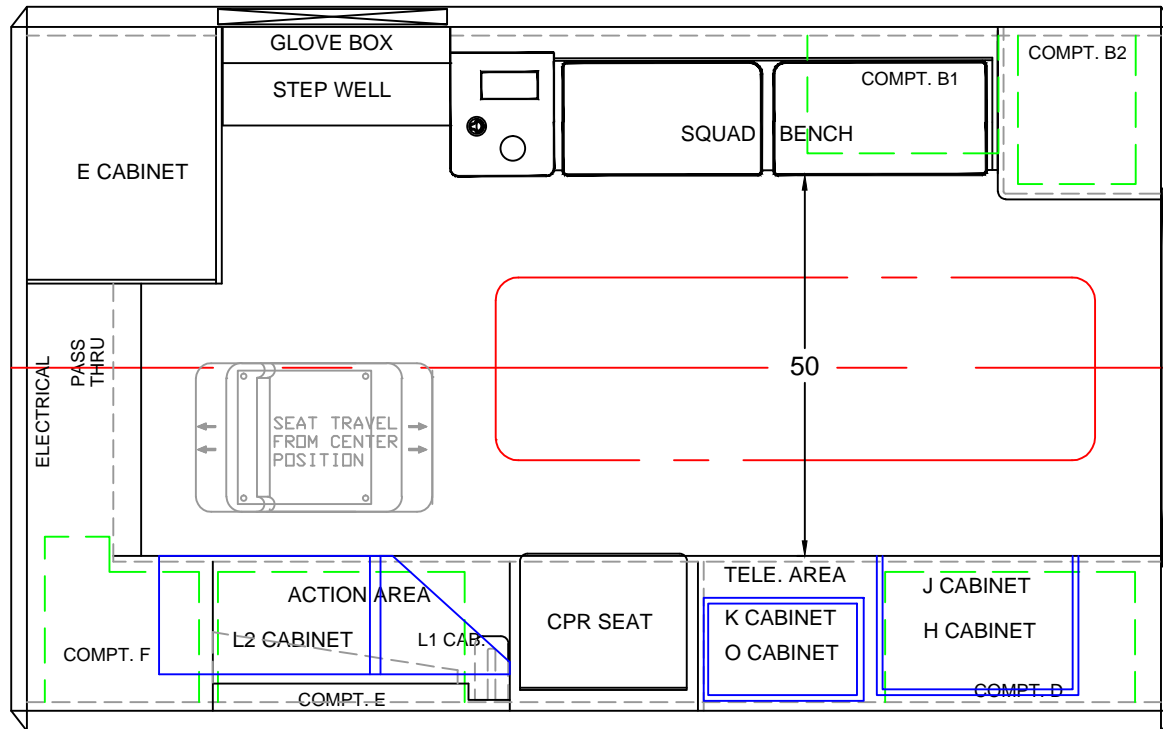

BE ADVISED THAT THESE ARE PRELIMINARY LAYOUTS INTENDED TO ILLUSTRATE DESIGN INTENT AND DIMENSIONS ARE FOR REFERENCE ONLY PRIOR TO FINAL ENGINEERING

INTERIOR CABINET DIMENSIONS IN INCHES

CABINET	HEIGHT	WIDTH	DEPTH	CABINET	HEIGHT	WIDTH	DEPTH



TYPE 1 DODGE 2018
FLOOR PLAN

DATE: 02/05/18 SCALE
DWN BY: SG DWG NO: 8 / 9

CA101270

MODEL 1153D

153 x 95 x 67

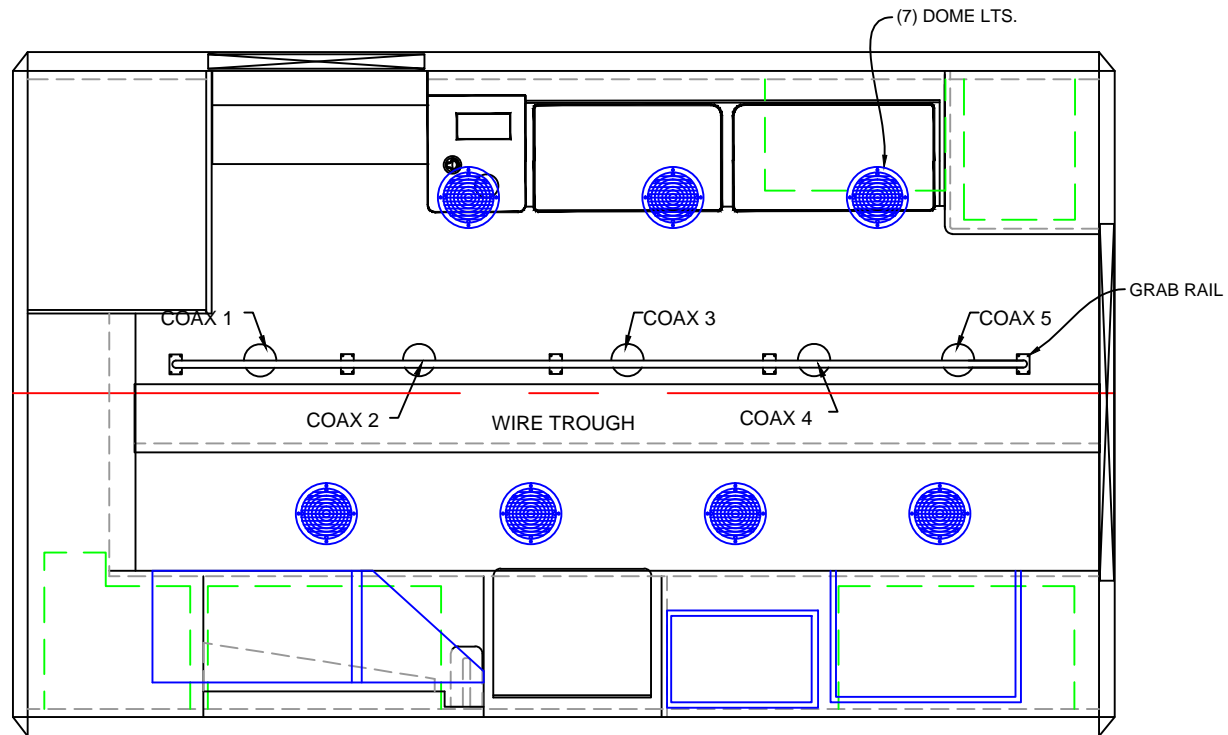

BE ADVISED THAT THESE ARE PRELIMINARY LAYOUTS INTENDED TO ILLUSTRATE DESIGN INTENT AND DIMENSIONS ARE FOR REFERENCE ONLY PRIOR TO FINAL ENGINEERING

INTERIOR CABINET DIMENSIONS IN INCHES

CABINET	HEIGHT	WIDTH	DEPTH	CABINET	HEIGHT	WIDTH	DEPTH



TYPE 1 DODGE 2018
LINER

DATE: 02/05/18 SCALE:
DWN BY: SG DWG NO: 9 / 9