

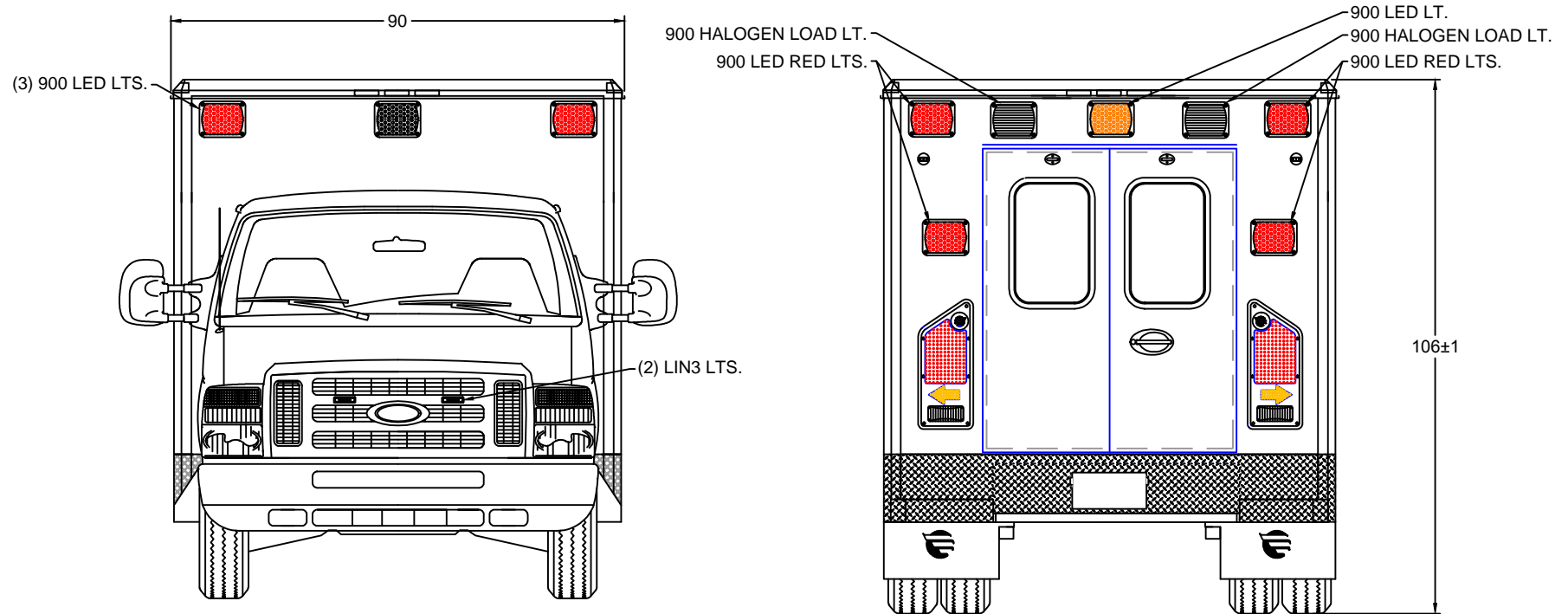

CA101242

MODEL 7146F CITIMEDIC

146 x 90 x 68



EXTERIOR COMPARTMENT DIMENSIONS IN INCHES													
INTERIOR DIMENSIONS				PASS THRU		INTERIOR DIMENSIONS				JAMB OPENING			
COMPT.	HEIGHT	WIDTH	DEPTH	HEIGHT	WIDTH	COMPT.	HEIGHT	WIDTH	DEPTH	HEIGHT	WIDTH		
													E-350 TYPE 7 FORD 2018 FRONT / REAR EXTERIOR VIEWS
49" AISLE						BE ADVISED THAT THESE ARE PRELIMINARY LAYOUTS INTENDED TO ILLUSTRATE DESIGN INTENT AND DIMENSIONS ARE FOR REFERENCE ONLY PRIOR TO FINAL ENGINEERING						DATE: 04/26/18 DWN BY: SG	SCALE: DWG NO: 1 / 9

CA101242

MODEL 7146F CITIMEDIC

146 x 90 x 68

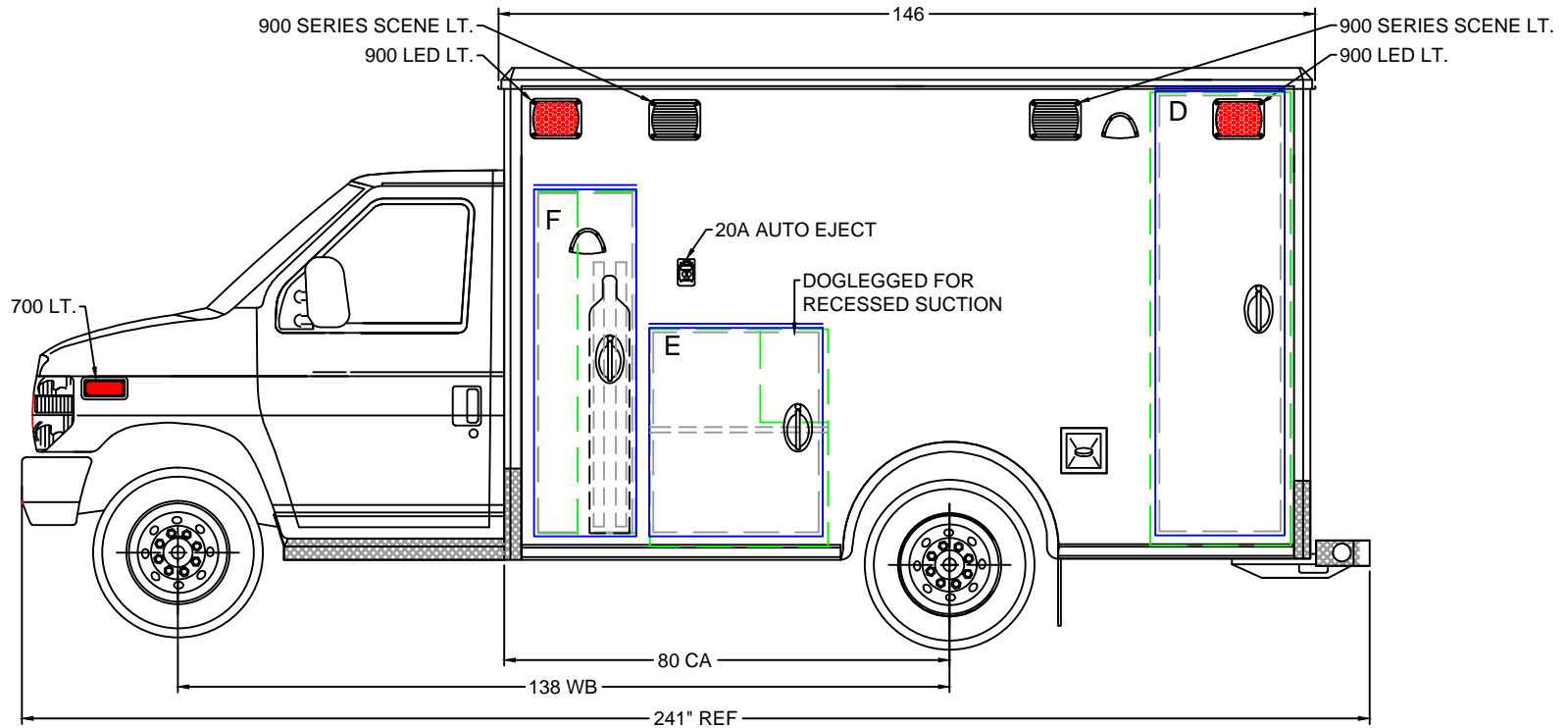

BE ADVISED THAT THESE ARE PRELIMINARY LAYOUTS INTENDED TO ILLUSTRATE DESIGN INTENT AND DIMENSIONS ARE FOR REFERENCE ONLY PRIOR TO FINAL ENGINEERING

EXTERIOR COMPARTMENT DIMENSIONS IN INCHES											
INTERIOR DIMENSIONS				JAMB OPENING		INTERIOR DIMENSIONS				JAMB OPENING	
COMPT.	HEIGHT	WIDTH	DEPTH	HEIGHT	WIDTH	COMPT.	HEIGHT	WIDTH	DEPTH	HEIGHT	WIDTH
D	81.00	25.00	8.00	77.75	21.50						
E	38.75	31.75	15.00	35.75	30.00						
F	61.00	17.50	15.00	60.50	16.75						
49" AISLE											



E-350 TYPE 7 FORD 2018

LEFT EXT. VIEW

DATE	04/26/18	SCALE	
DRAWN BY	SG	DWG NO	2 / 9

CA101242

MODEL 7146F CITIMEDIC

146 x 90 x 68

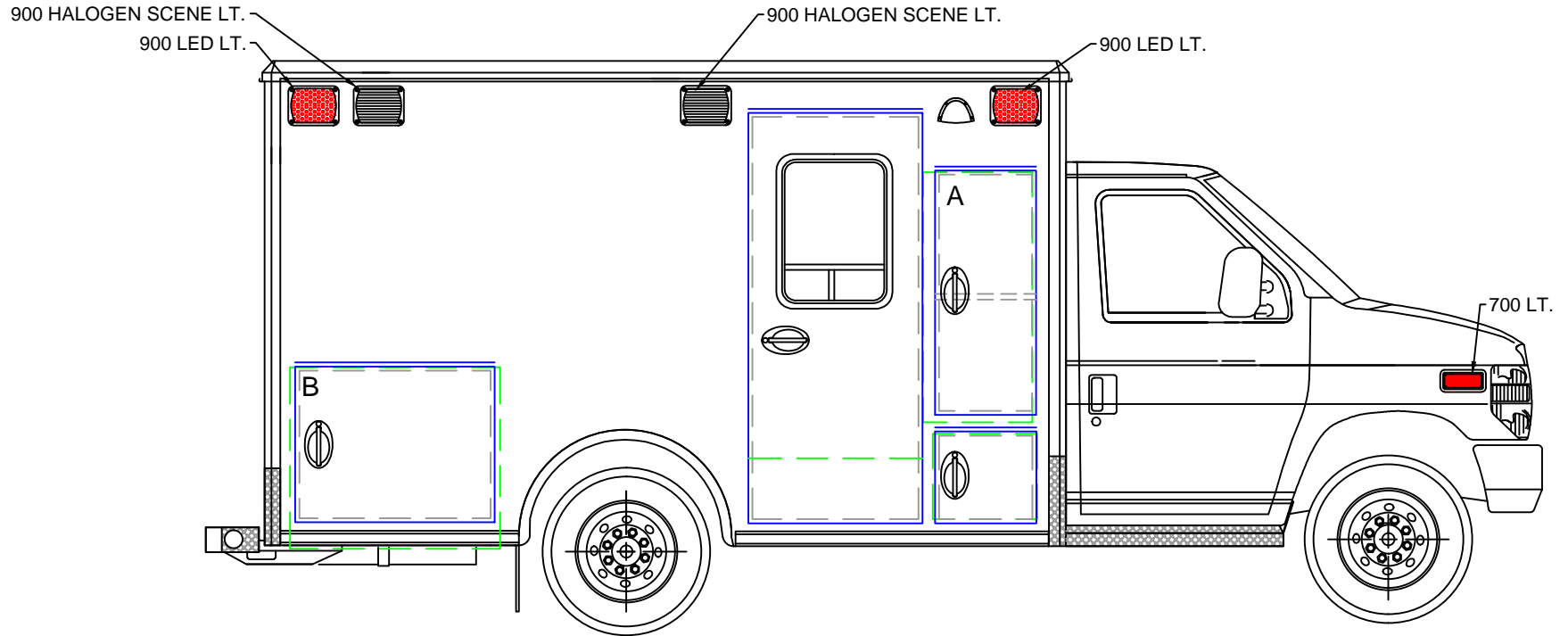

BE ADVISED THAT THESE ARE PRELIMINARY LAYOUTS INTENDED TO ILLUSTRATE DESIGN INTENT AND DIMENSIONS ARE FOR REFERENCE ONLY PRIOR TO FINAL ENGINEERING

EXTERIOR COMPARTMENT DIMENSIONS IN INCHES											
INTERIOR DIMENSIONS				JAMB OPENING		INTERIOR DIMENSIONS				JAMB OPENING	
COMPT.	HEIGHT	WIDTH	DEPTH	HEIGHT	WIDTH	COMPT.	HEIGHT	WIDTH	DEPTH	HEIGHT	WIDTH
A	45.25	19.75	31.50	42.75	16.75						
B	32.75	38.00	15.50	26.75	34.50						
LOWER-A	15.50	19.00	18.50	15.00	16.75						
49" AISLE											



**Wheelchair
Coach**

E-350 TYPE 7 FORD 2018

RIGHT EXT. VIEW

DATE 04/26/18 SCALE

DRAWN BY SG DWG NO 3 / 9

CA101242

MODEL 7146F CITIMEDIC

146 x 90 x 68

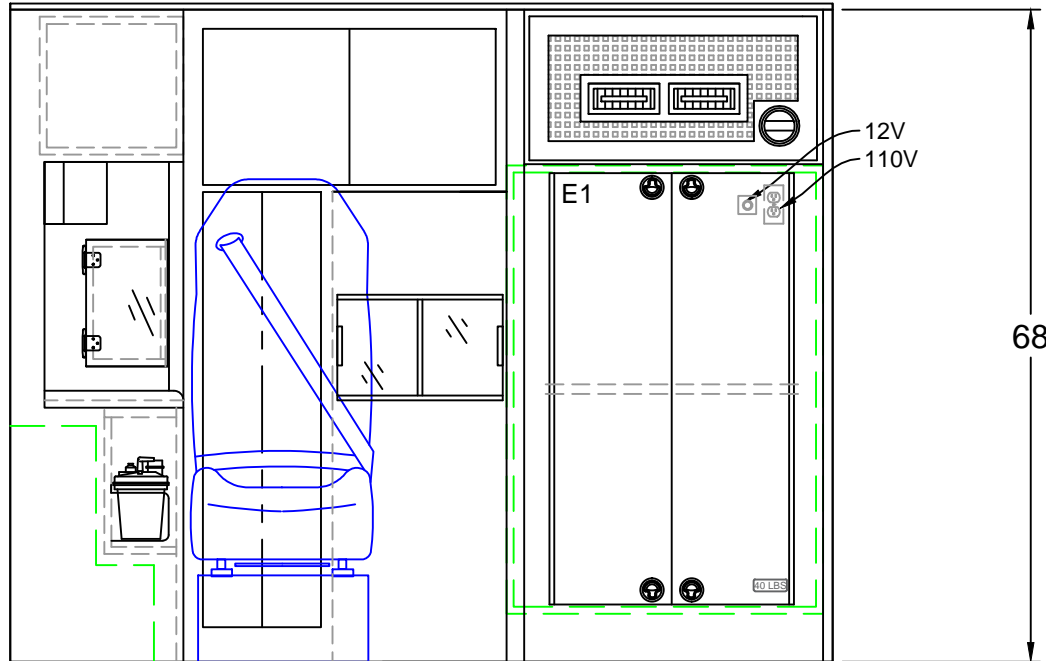

BE ADVISED THAT THESE ARE PRELIMINARY LAYOUTS INTENDED TO ILLUSTRATE DESIGN INTENT AND DIMENSIONS ARE FOR REFERENCE ONLY PRIOR TO FINAL ENGINEERING

INTERIOR CABINET DIMENSIONS IN INCHES											
CABINET	HEIGHT	WIDTH	DEPTH	CABINET	HEIGHT	WIDTH	DEPTH				
E1	45.25	31.50	19.75					E-350 TYPE 7 FORD 2018 BULKHEAD INTERIOR			
49" AISLE								DATE	04/26/18	SCALE	
								DRAWN BY	SG	DWG NO	4 / 9

CA101242

MODEL 7146F CITIMEDIC

146 x 90 x 68

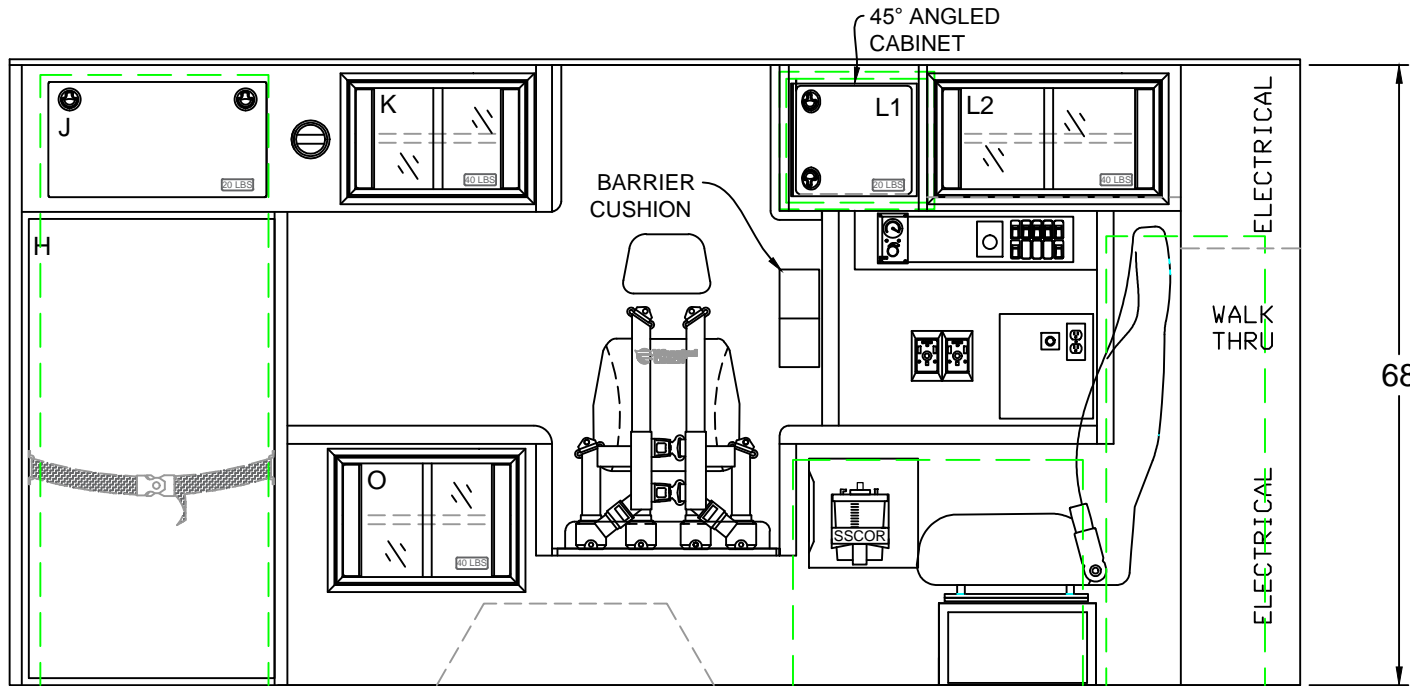

INTERIOR CABINET DIMENSIONS IN INCHES

CABINET	HEIGHT	WIDTH	DEPTH		CABINET	HEIGHT	WIDTH	DEPTH	
H	50.50	26.75	7.00		O	14.25	20.25	16.00	
J	12.75	24.00	7.00						
K	12.75	45.00	16.00						
L1	13.50	15.50	16.00						
L2	12.75	25.00	13.50						



E-350 TYPE 7 FORD 2018

LEFT INTERIOR

DATE: 04/26/18 SCALE:

DWN BY: SG DWG NO: 5 / 9

49" AISLE

BE ADVISED THAT THESE ARE PRELIMINARY LAYOUTS INTENDED TO ILLUSTRATE DESIGN INTENT AND DIMENSIONS ARE FOR REFERENCE ONLY PRIOR TO FINAL ENGINEERING

CA101242

MODEL 7146F CITIMEDIC

146 x 90 x 68

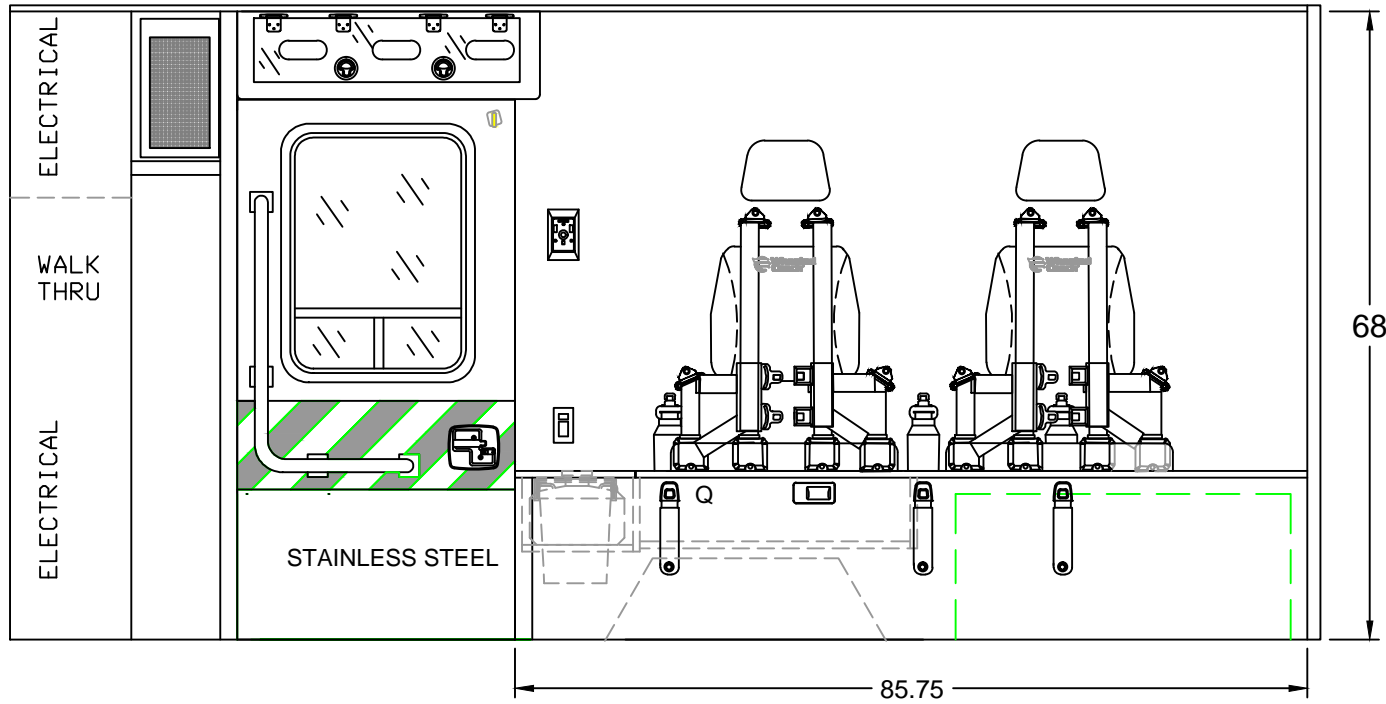

INTERIOR CABINET DIMENSIONS IN INCHES

COMPT.	HEIGHT	WIDTH	DEPTH		COMPT.	HEIGHT	WIDTH	DEPTH	
Q	6.75	29.25	16.00						

49" AISLE

BE ADVISED THAT THESE ARE PRELIMINARY LAYOUTS INTENDED TO ILLUSTRATE DESIGN INTENT AND DIMENSIONS ARE FOR REFERENCE ONLY PRIOR TO FINAL ENGINEERING



E-350 TYPE 7 FORD 2018
RIGHT INTERIOR

DATE: 04/26/18

SCALE

DRAWN BY

SG

DWG NO

6 / 9

CA101242

MODEL 7146F CITIMEDIC

146 x 90 x 68

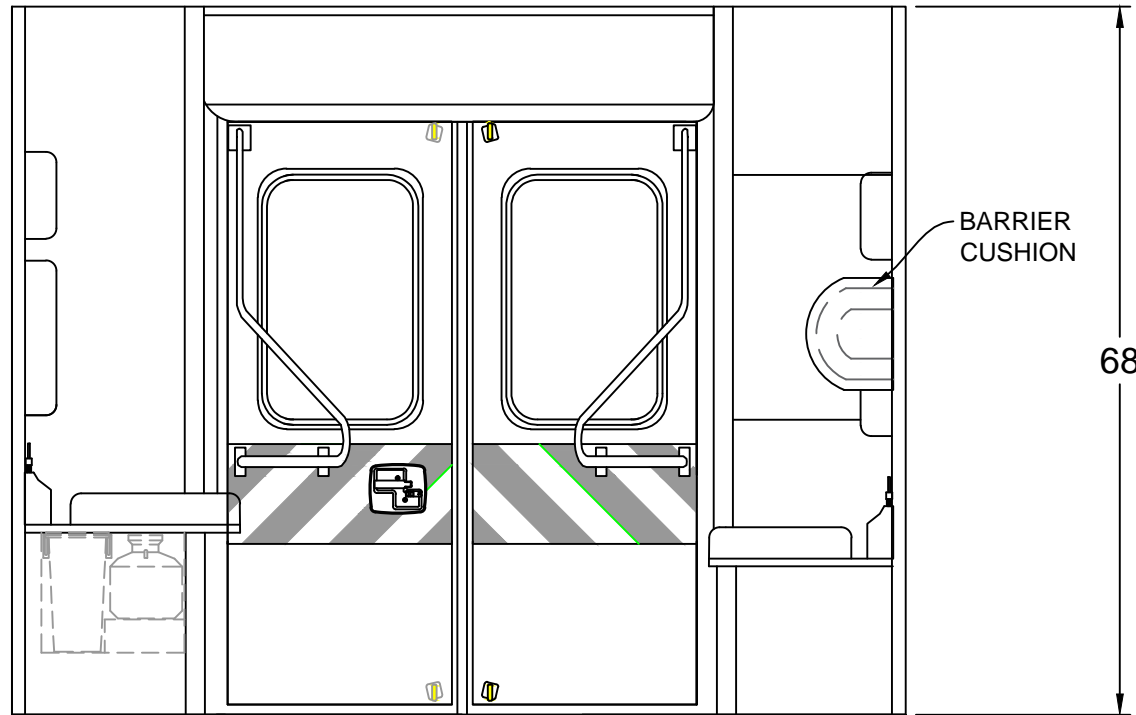

INTERIOR CABINET DIMENSIONS IN INCHES



E-350 TYPE 7 FORD 2018

REAR BULKHEAD INTERIOR

DATE: 04/26/18

SCALE

DWY BY

SG

DWG NO

7 / 9

COMPT.	HEIGHT	WIDTH	DEPTH		COMPT.	HEIGHT	WIDTH	DEPTH	

49" AISLE

BE ADVISED THAT THESE ARE PRELIMINARY LAYOUTS INTENDED TO ILLUSTRATE DESIGN INTENT AND DIMENSIONS ARE FOR REFERENCE ONLY PRIOR TO FINAL ENGINEERING

CA101242

MODEL 7146F CITIMEDIC

146 x 90 x 68

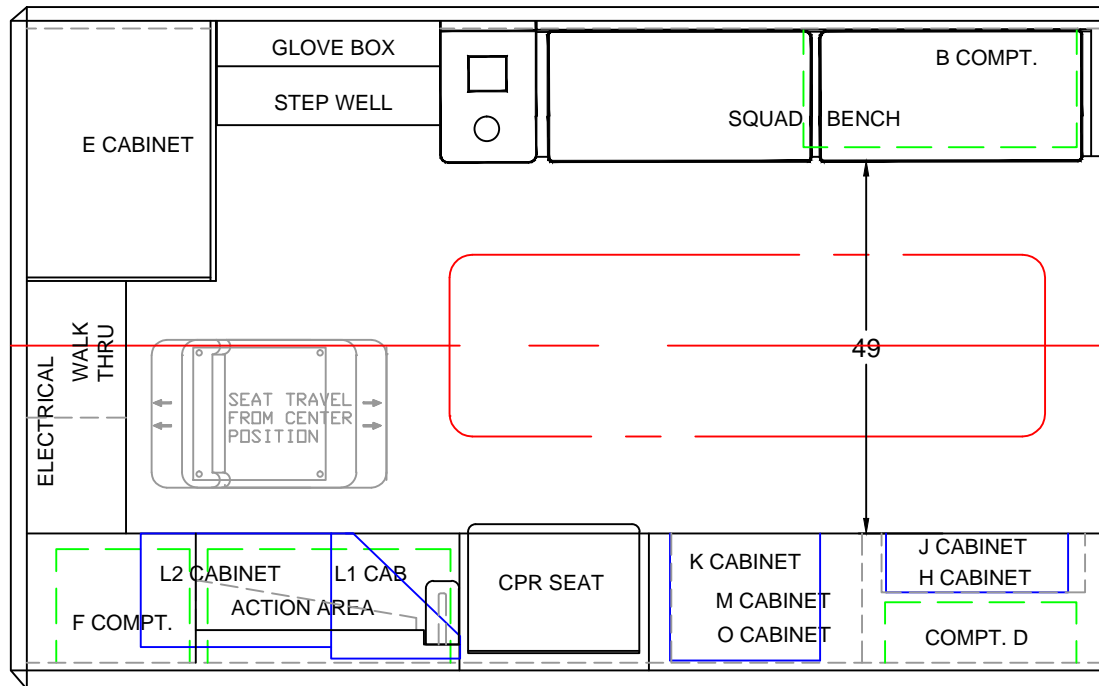

BE ADVISED THAT THESE ARE PRELIMINARY LAYOUTS INTENDED TO ILLUSTRATE DESIGN INTENT AND DIMENSIONS ARE FOR REFERENCE ONLY PRIOR TO FINAL ENGINEERING

INTERIOR CABINET DIMENSIONS IN INCHES

CABINET	HEIGHT	WIDTH	DEPTH	CABINET	HEIGHT	WIDTH	DEPTH



E-350 TYPE 7 FORD 2018
FLOOR PLAN

DATE: 04/26/18 SCALE:
OWN BY: SG DWG NO: 8 / 9

49" AISLE

CA101242

MODEL 7146F CITIMEDIC

146 x 90 x 68

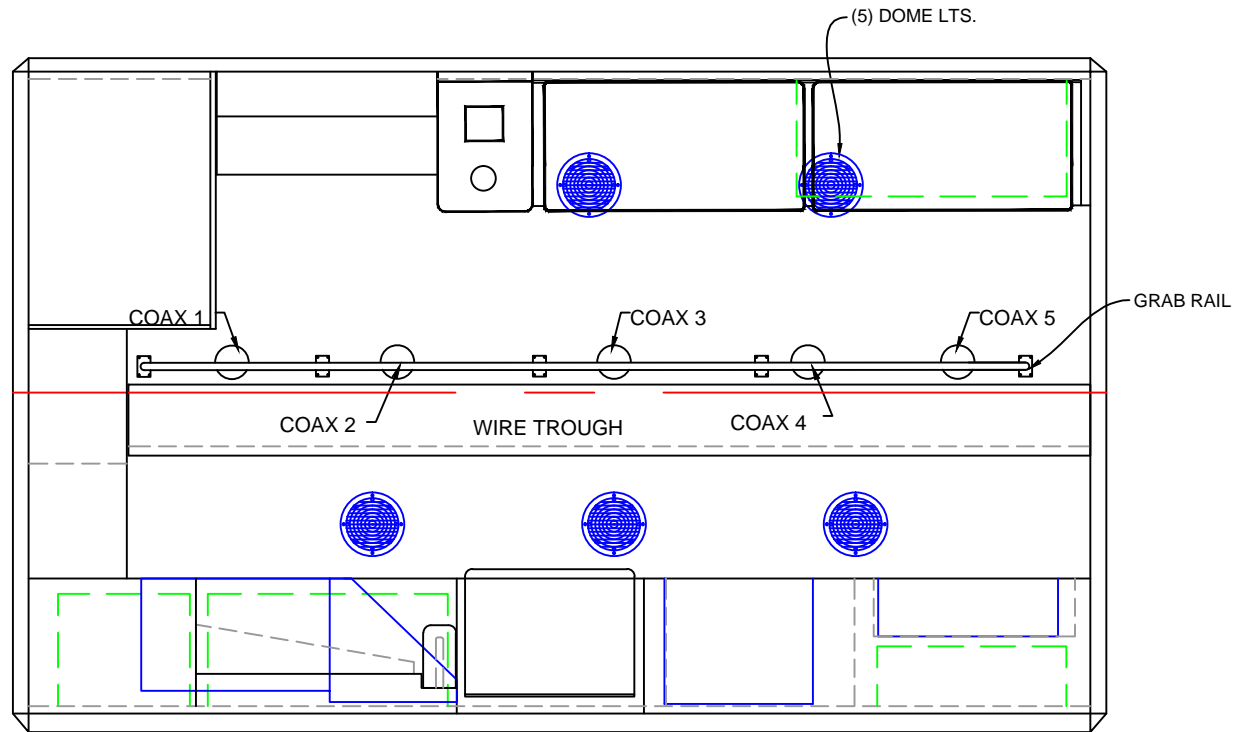

BE ADVISED THAT THESE ARE PRELIMINARY LAYOUTS INTENDED TO ILLUSTRATE DESIGN INTENT AND DIMENSIONS ARE FOR REFERENCE ONLY PRIOR TO FINAL ENGINEERING

INTERIOR CABINET DIMENSIONS IN INCHES

CABINET	HEIGHT	WIDTH	DEPTH	CABINET	HEIGHT	WIDTH	DEPTH



E-350 TYPE 7 FORD 2018

LINER

DATE: 04/26/18 SCALE:
 DWN BY: SG DWG NO: 9 / 9

49" AISLE