

CA101339

MODEL 1146F

146 x 90 x 68

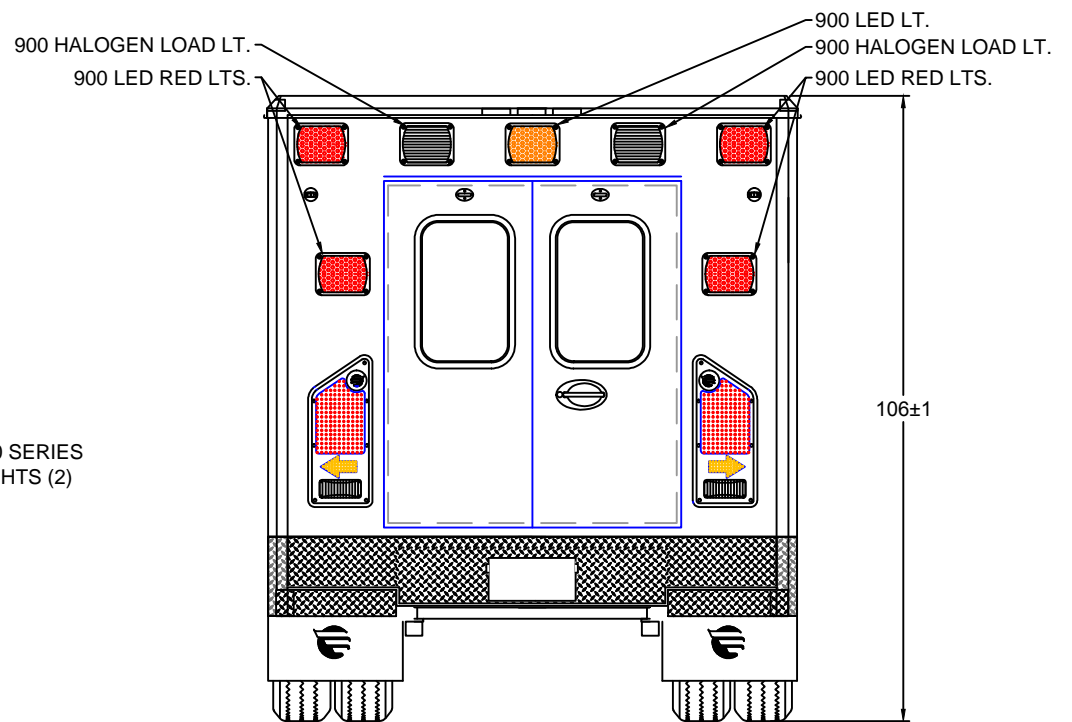
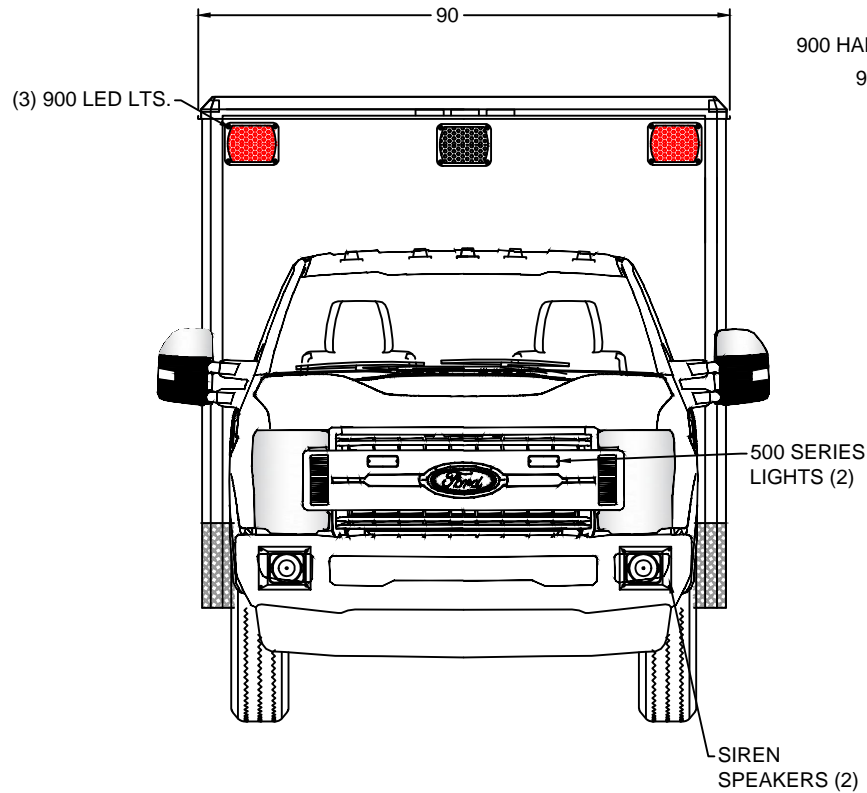

EXTERIOR COMPARTMENT DIMENSIONS IN INCHES

INTERIOR DIMENSIONS				PASS THRU		INTERIOR DIMENSIONS				JAMB OPENING	
COMPT.	HEIGHT	WIDTH	DEPTH	HEIGHT	WIDTH	COMPT.	HEIGHT	WIDTH	DEPTH	HEIGHT	WIDTH



TYPE 1 FORD 2018  
FRONT / REAR  
EXTERIOR VIEWS

BE ADVISED THAT THESE ARE PRELIMINARY LAYOUTS INTENDED TO ILLUSTRATE DESIGN INTENT AND DIMENSIONS ARE FOR REFERENCE ONLY PRIOR TO FINAL ENGINEERING

DATE:	04/17/18	SCALE
DWN BY	SG	DWG NO 1 / 9

49" AISLE

CA101339

MODEL 1146F

146 x 90 x 68

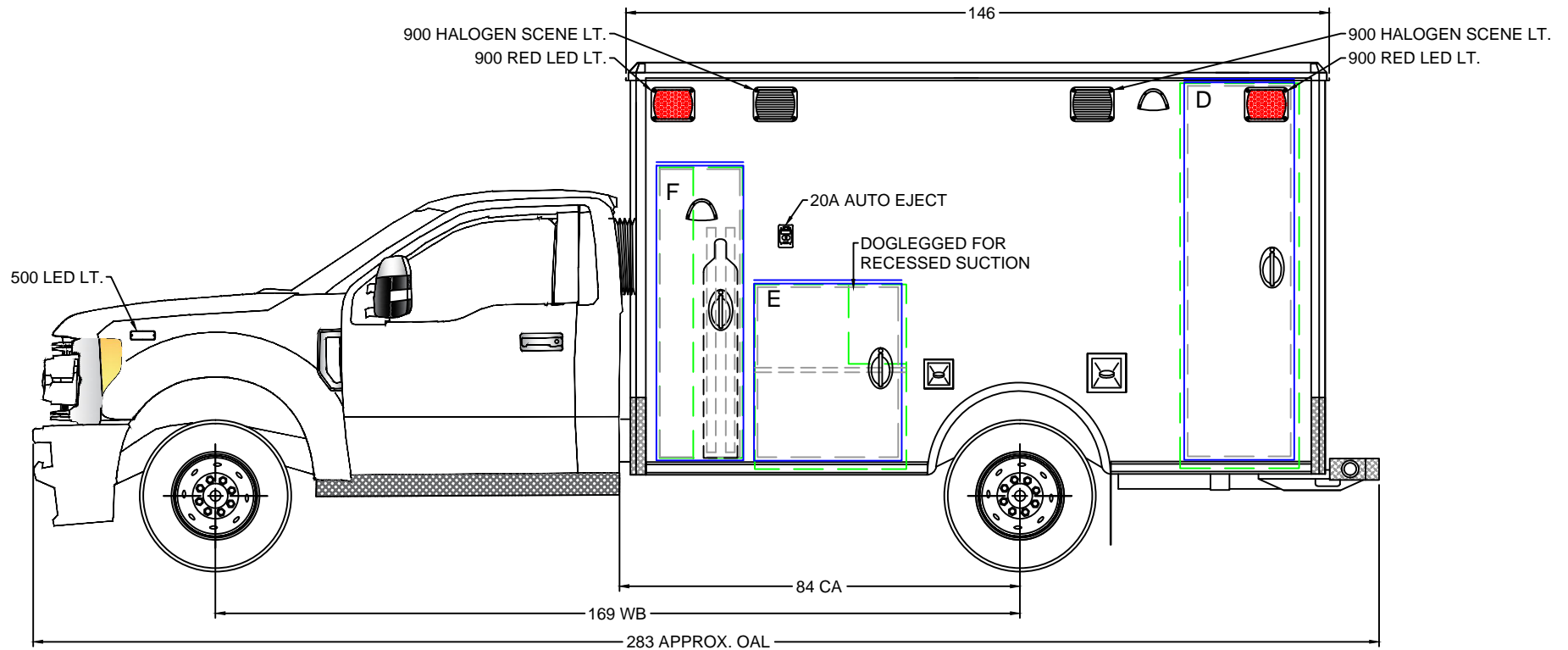

BE ADVISED THAT THESE ARE PRELIMINARY LAYOUTS INTENDED TO ILLUSTRATE DESIGN INTENT AND DIMENSIONS ARE FOR REFERENCE ONLY PRIOR TO FINAL ENGINEERING

EXTERIOR COMPARTMENT DIMENSIONS IN INCHES												
INTERIOR DIMENSIONS				JAMB OPENING		INTERIOR DIMENSIONS				JAMB OPENING		
COMPT.	HEIGHT	WIDTH	DEPTH	HEIGHT	WIDTH	COMPT.	HEIGHT	WIDTH	DEPTH	HEIGHT	WIDTH	
D	81.00	25.00	8.00	77.75	21.50							
E	38.75	31.75	15.00	35.75	29.50							
F	61.00	17.50	15.00	60.50	16.75							
49" AISLE												DATE 04/17/18 DRAWN BY SG
												SCALE DWG NO 2 / 9

CA101339

MODEL 1146F

146 x 90 x 68

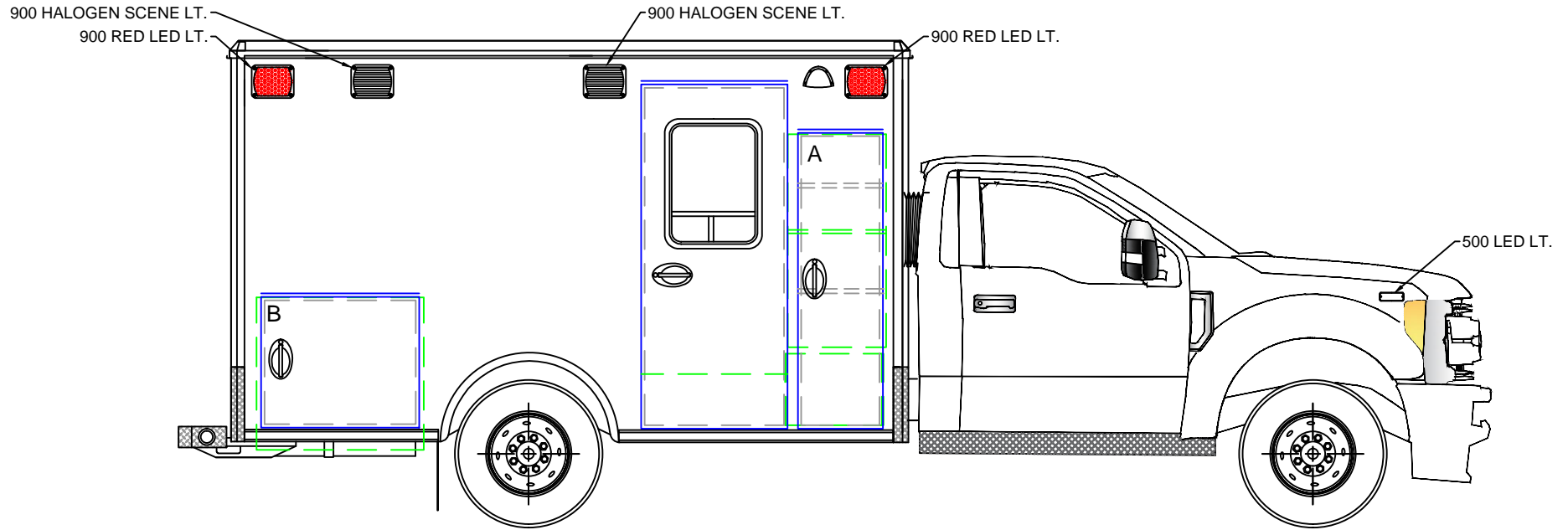

BE ADVISED THAT THESE ARE PRELIMINARY LAYOUTS INTENDED TO ILLUSTRATE DESIGN INTENT AND DIMENSIONS ARE FOR REFERENCE ONLY PRIOR TO FINAL ENGINEERING

EXTERIOR COMPARTMENT DIMENSIONS IN INCHES												
INTERIOR DIMENSIONS				JAMB OPENING		INTERIOR DIMENSIONS				JAMB OPENING		
COMPT.	HEIGHT	WIDTH	DEPTH	HEIGHT	WIDTH	COMPT.	HEIGHT	WIDTH	DEPTH	HEIGHT	WIDTH	
A	45.25	21.25	32.50	61.50	16.75							TYPE 1 FORD 2018 RIGHT EXT. VIEW
LOWER-A	15.50	19.00	18.75									
B	33.00	36.00	15.50	26.75	32.50							
49" AISLE												DATE 04/17/18 SCALE DRAWN BY SG DWG NO 3 / 9

CA101339

MODEL 1146F

146 x 90 x 68

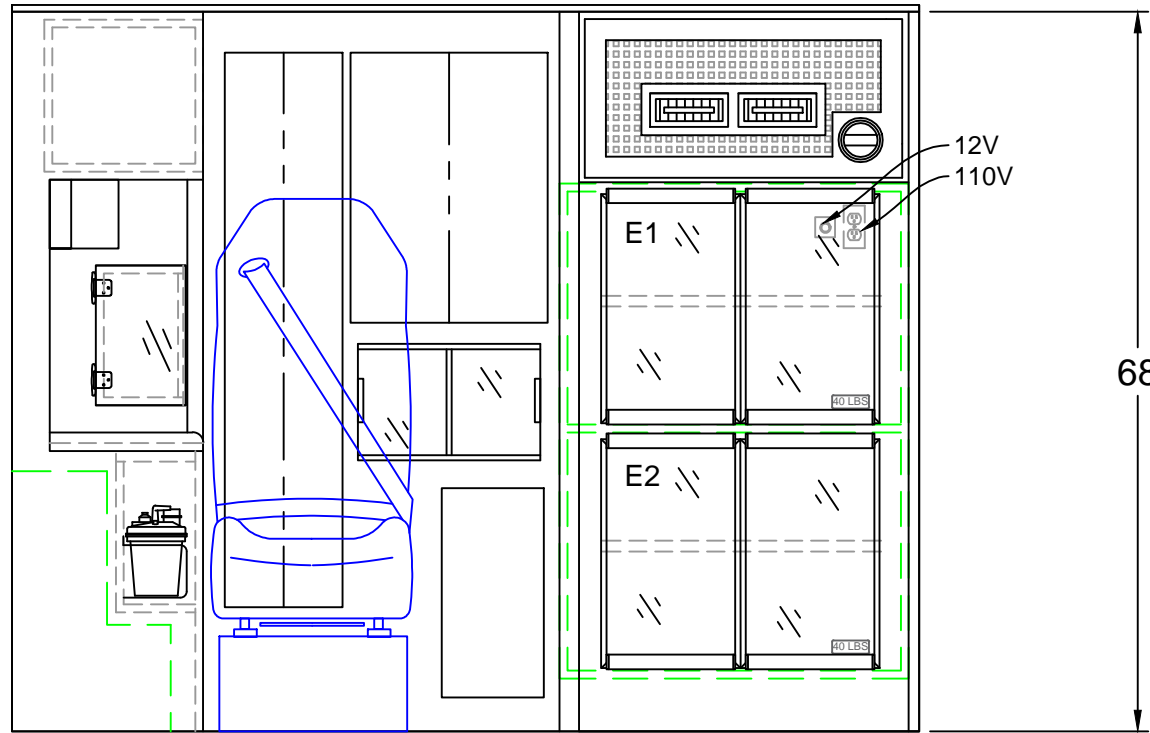

BE ADVISED THAT THESE ARE PRELIMINARY LAYOUTS INTENDED TO ILLUSTRATE DESIGN INTENT AND DIMENSIONS ARE FOR REFERENCE ONLY PRIOR TO FINAL ENGINEERING

<p>CABINET WEIGHT RATINGS:                  RESTOCKING = 30 LBS.                  NON-RESTOCKING = 40 LBS.</p>	<p>INTERIOR CABINET DIMENSIONS IN INCHES</p>								
	CABINET	HEIGHT	WIDTH	DEPTH	CABINET	HEIGHT	WIDTH	DEPTH	
	E1	22.00	32.50	21.25					
	E2	22.00	32.50	21.25					
									DATE 04/17/18      SCALE
									DRAWN BY SG      DWG NO 4 / 9

49" AISLE

CA101339

MODEL 1146F

146 x 90 x 68

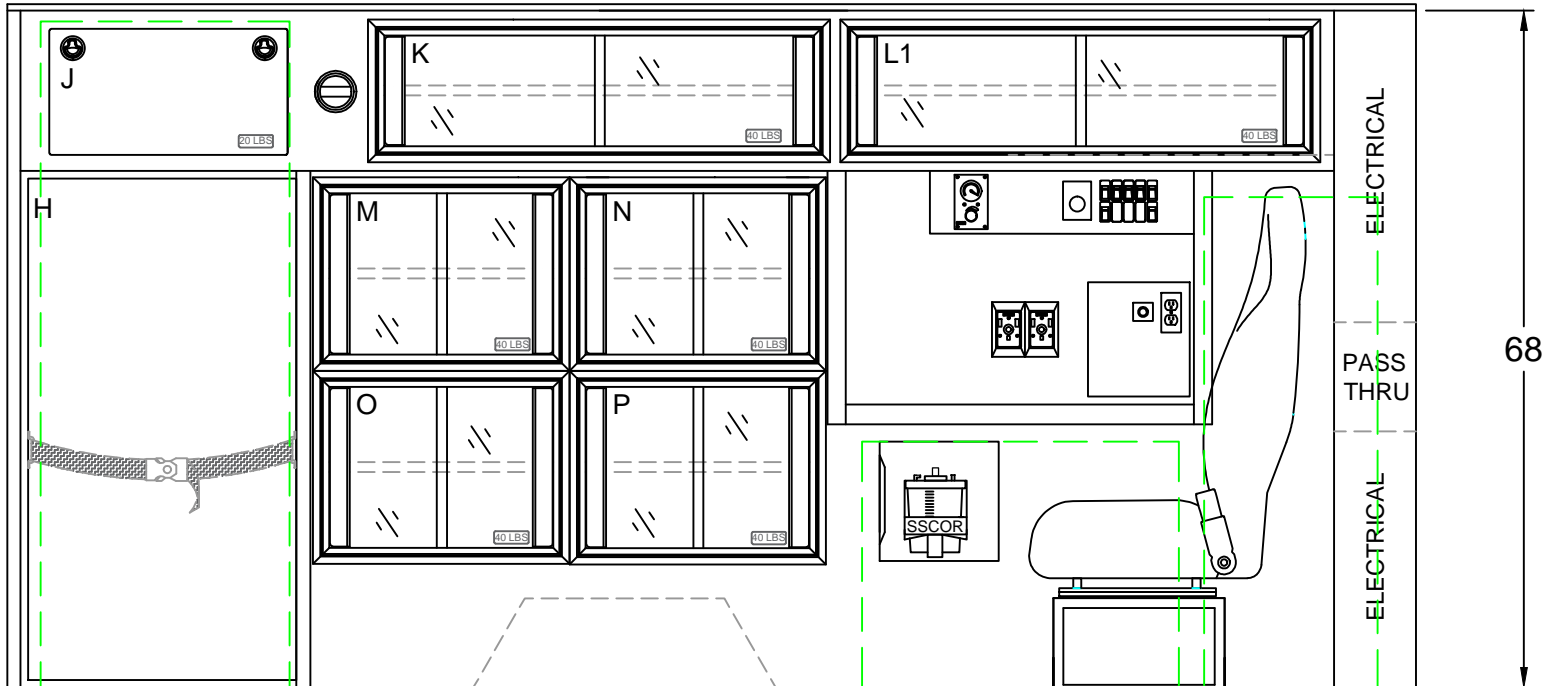

INTERIOR CABINET DIMENSIONS IN INCHES

CABINET	HEIGHT	WIDTH	DEPTH		CABINET	HEIGHT	WIDTH	DEPTH	
H	50.50	26.75	7.75		M-N	18.00	24.25	16.00	
J	12.75	24.00	7.00		O-P	18.00	24.25	16.00	
K	12.75	45.00	16.00						
L1	12.75	46.75	13.50						



TYPE 1 FORD 2018

LEFT INTERIOR

DATE:	04/17/18	SCALE:	
DWN BY:	SG	DWG NO:	5 / 9

49" AISLE

**CABINET WEIGHT RATINGS:**  
 RESTOCKING = 30 LBS.  
 NON-RESTOCKING = 40 LBS.

BE ADVISED THAT THESE ARE PRELIMINARY LAYOUTS INTENDED TO ILLUSTRATE DESIGN INTENT AND DIMENSIONS ARE FOR REFERENCE ONLY PRIOR TO FINAL ENGINEERING

CA101339

MODEL 1146F

146 x 90 x 68

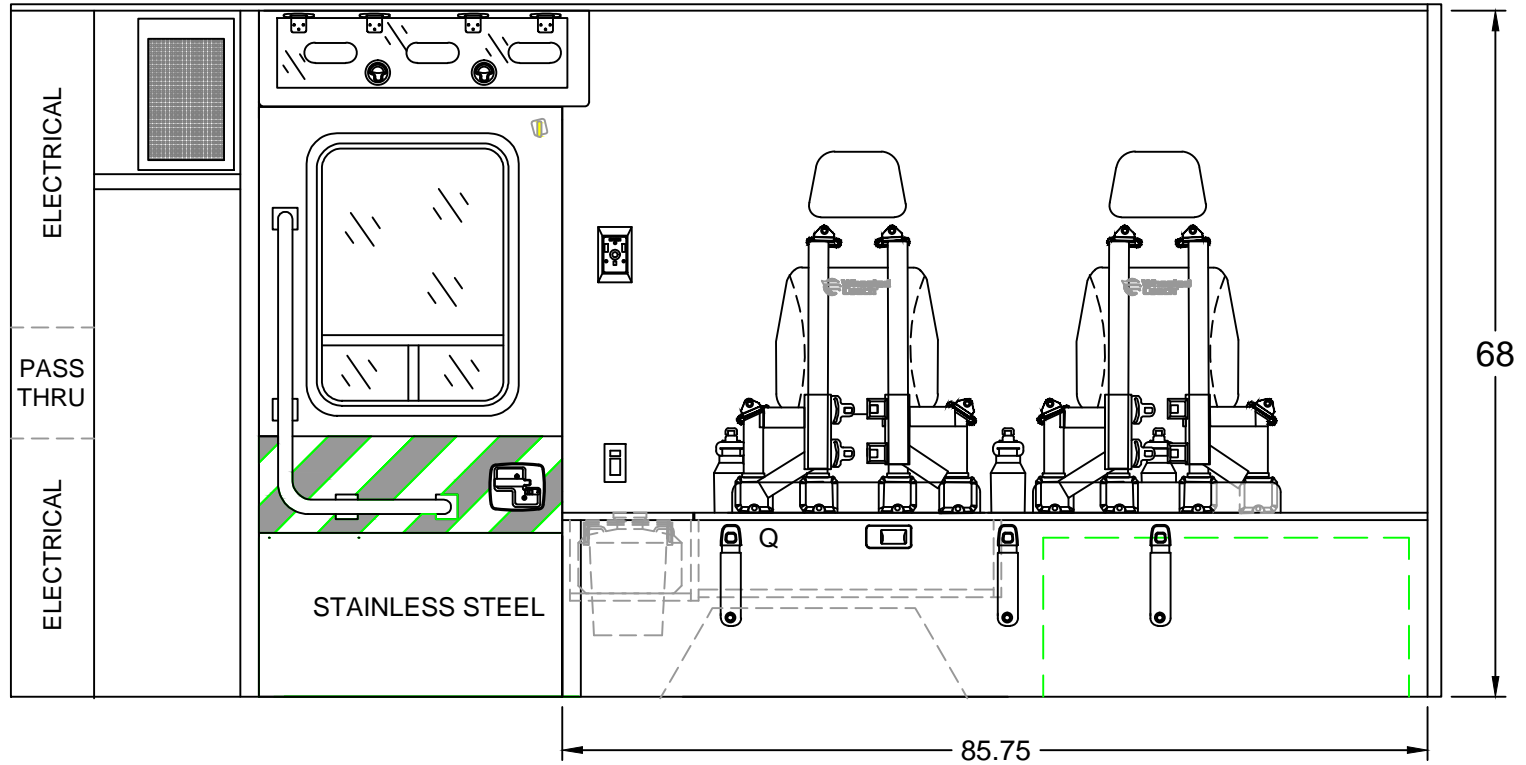

INTERIOR CABINET DIMENSIONS IN INCHES

COMPT.	HEIGHT	WIDTH	DEPTH		COMPT.	HEIGHT	WIDTH	DEPTH	
Q	6.75	29.25	16.00						

49" AISLE

**CABINET WEIGHT RATINGS:**  
 RESTOCKING = 30 LBS.  
 NON-RESTOCKING = 40 LBS.

BE ADVISED THAT THESE ARE PRELIMINARY LAYOUTS INTENDED TO ILLUSTRATE DESIGN INTENT AND DIMENSIONS ARE FOR REFERENCE ONLY PRIOR TO FINAL ENGINEERING



TYPE 1 FORD 2018  
 RIGHT INTERIOR

DATE: 04/17/18

SCALE

DWN BY

SG

DWG NO

6 / 9

CA101339

MODEL 1146F

146 x 90 x 68

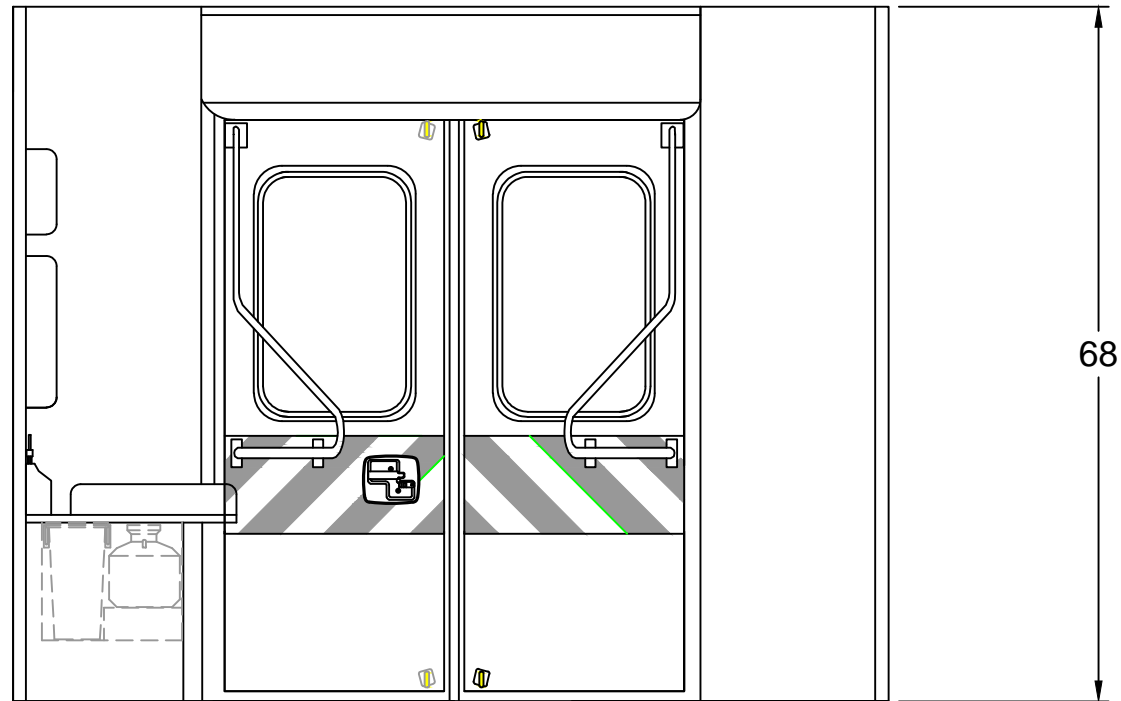

INTERIOR CABINET DIMENSIONS IN INCHES



TYPE 1 FORD 2018

REAR BULKHEAD INTERIOR

DATE:	04/17/18	SCALE	
DRAWN BY:	SG	DWG NO:	7 / 9

COMPT.	HEIGHT	WIDTH	DEPTH	COMPT.	HEIGHT	WIDTH	DEPTH

49" AISLE

**CABINET WEIGHT RATINGS:**  
 RESTOCKING = 30 LBS.  
 NON-RESTOCKING = 40 LBS.

BE ADVISED THAT THESE ARE PRELIMINARY LAYOUTS INTENDED TO ILLUSTRATE DESIGN INTENT AND DIMENSIONS ARE FOR REFERENCE ONLY PRIOR TO FINAL ENGINEERING

CA101339

MODEL 1146F

146 x 90 x 68

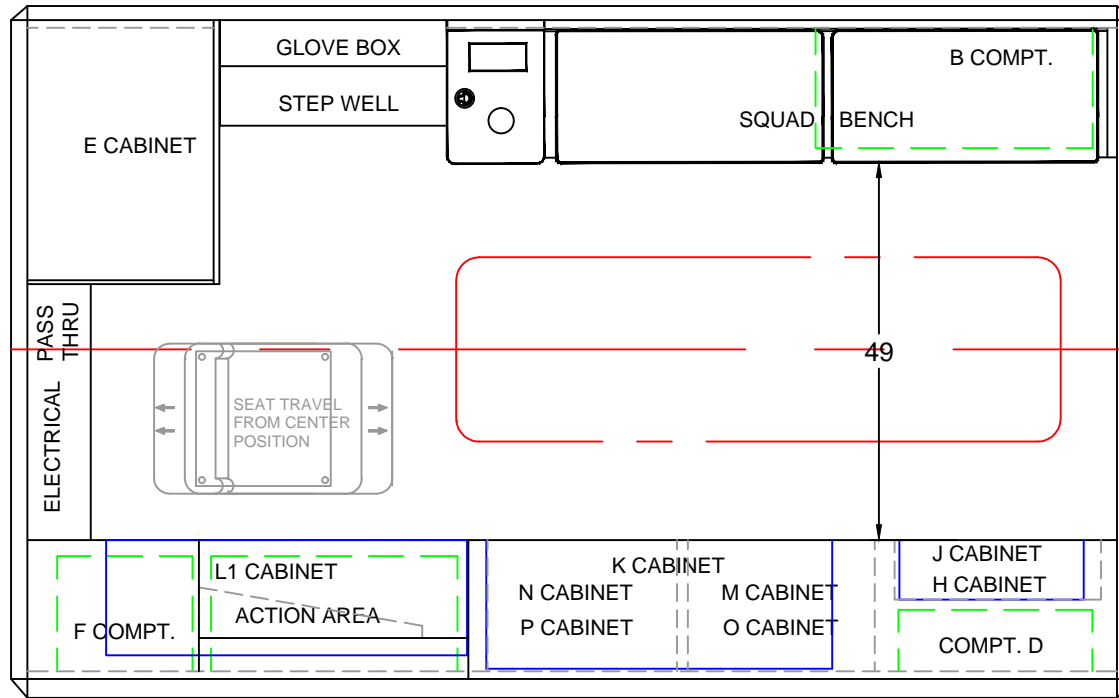

BE ADVISED THAT THESE ARE PRELIMINARY LAYOUTS INTENDED TO ILLUSTRATE DESIGN INTENT AND DIMENSIONS ARE FOR REFERENCE ONLY PRIOR TO FINAL ENGINEERING

INTERIOR CABINET DIMENSIONS IN INCHES									
CABINET	HEIGHT	WIDTH	DEPTH	CABINET	HEIGHT	WIDTH	DEPTH		
								TYPE 1 FORD 2018 FLOOR PLAN	
								DATE: 04/17/18	SCALE:
								DWN BY: SG	DWG NO: 8 / 9

49" AISLE



CA101339

MODEL 1146F

146 x 90 x 68

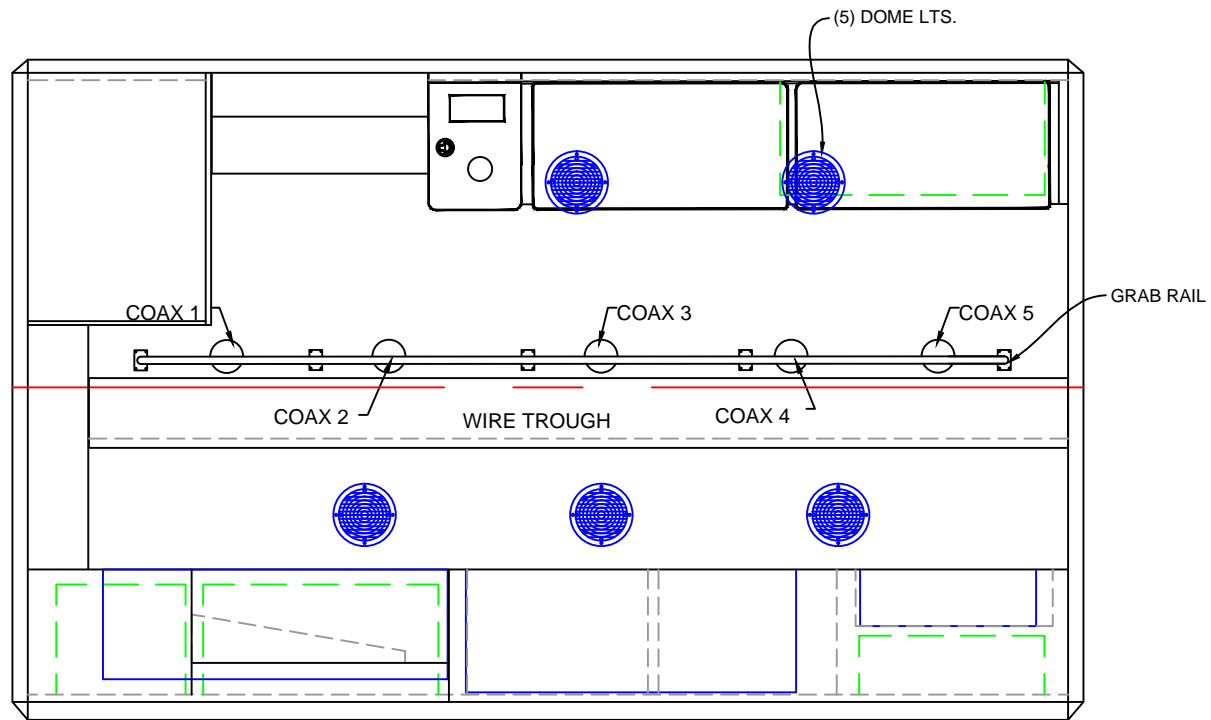

BE ADVISED THAT THESE ARE PRELIMINARY LAYOUTS INTENDED TO ILLUSTRATE DESIGN INTENT AND DIMENSIONS ARE FOR REFERENCE ONLY PRIOR TO FINAL ENGINEERING

INTERIOR CABINET DIMENSIONS IN INCHES

CABINET	HEIGHT	WIDTH	DEPTH	CABINET	HEIGHT	WIDTH	DEPTH



TYPE 1 FORD 2018

LINER

DATE:	04/17/18	SCALE:	
DWN BY:	SG	DWG NO:	9 / 9

49" AISLE