

CA111117

MODEL 1170D

170 x 95 x 72

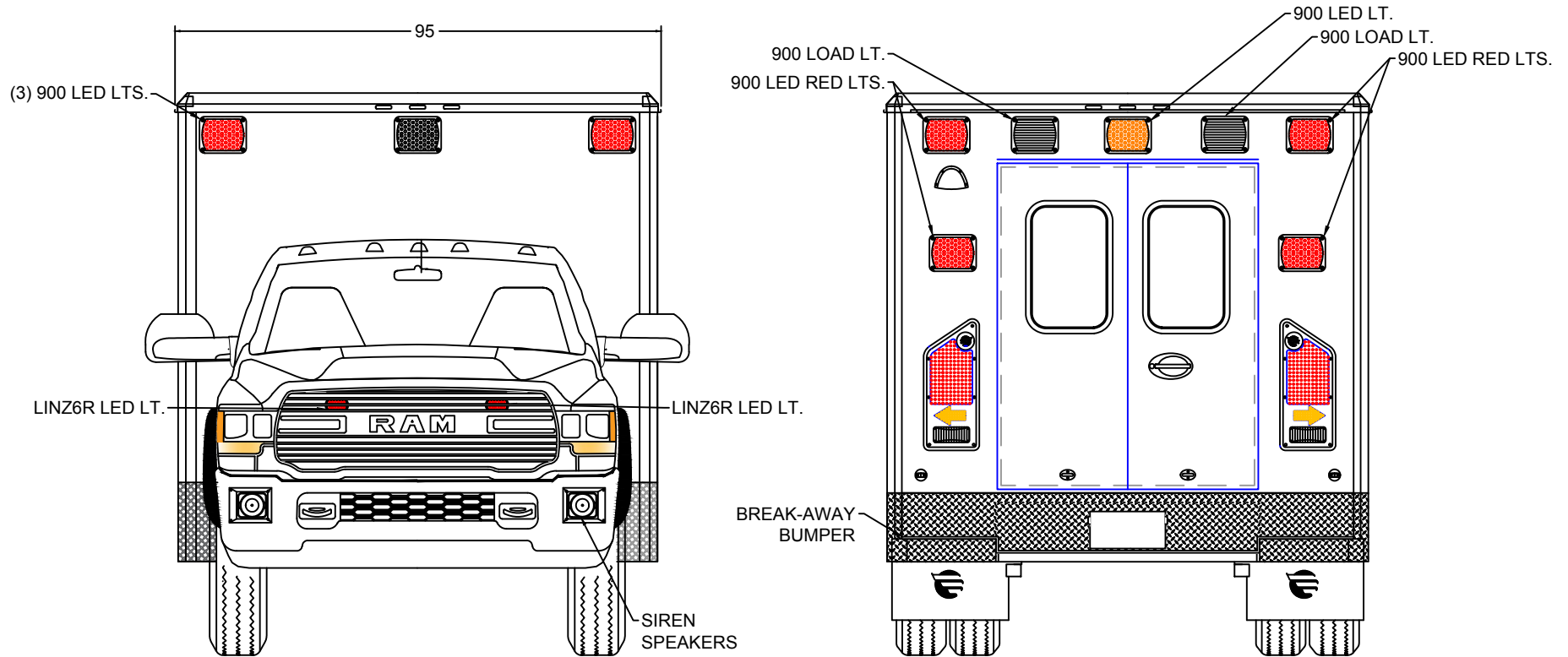

EXTERIOR COMPARTMENT DIMENSIONS IN INCHES

INTERIOR DIMENSIONS				PASS THRU		INTERIOR DIMENSIONS				JAMB OPENING	
COMPT.	HEIGHT	WIDTH	DEPTH	HEIGHT	WIDTH	COMPT.	HEIGHT	WIDTH	DEPTH	HEIGHT	WIDTH



TYPE 1 DODGE
FRONT / REAR
EXTERIOR VIEWS

BE ADVISED THAT THESE ARE PRELIMINARY LAYOUTS INTENDED TO ILLUSTRATE DESIGN INTENT AND DIMENSIONS ARE FOR REFERENCE ONLY PRIOR TO FINAL ENGINEERING

DATE:	3/5/21	SCALE
DWN BY	AP	DWG NO 1 / 9

50" AISLE

CA111117

MODEL 1170D

170 x 95 x 72

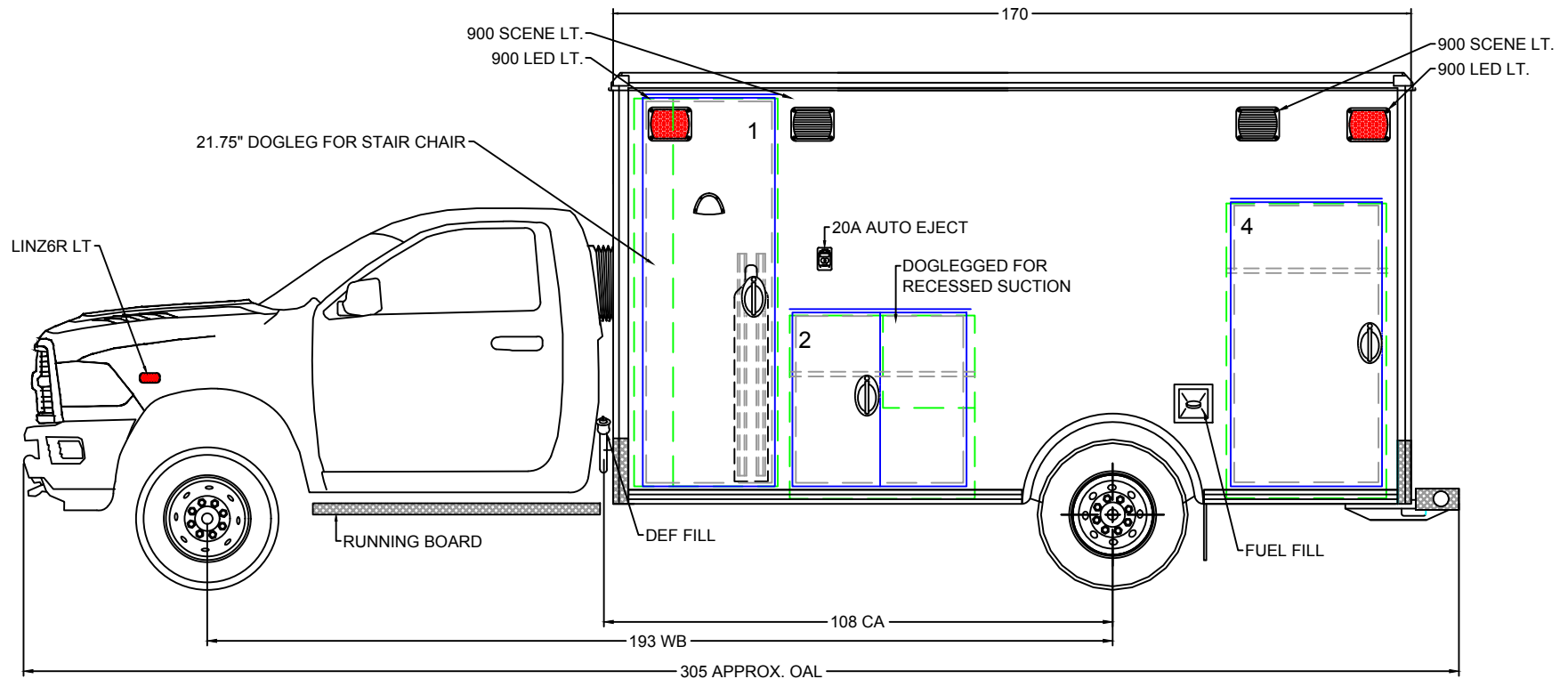

BE ADVISED THAT THESE ARE PRELIMINARY LAYOUTS INTENDED TO ILLUSTRATE DESIGN INTENT AND DIMENSIONS ARE FOR REFERENCE ONLY PRIOR TO FINAL ENGINEERING

EXTERIOR COMPARTMENT DIMENSIONS IN INCHES

INTERIOR DIMENSIONS				JAMB OPENING		INTERIOR DIMENSIONS				JAMB OPENING	
COMPT.	HEIGHT	WIDTH	DEPTH	HEIGHT	WIDTH	COMPT.	HEIGHT	WIDTH	DEPTH	HEIGHT	WIDTH
4	61.50	34.00	17.00	58.50	30.50						
2	37.75	39.25	17.00	35.00	37.00						
1	82.50	30.50	17.00	81.75	27.25						



TYPE 1 DODGE
LEFT EXT. VIEW

DATE	3/5/21	SCALE	
DRAWN BY	AP	DWG NO	2 / 9

50" AISLE

CA111117

MODEL 1170D

170 x 95 x 72

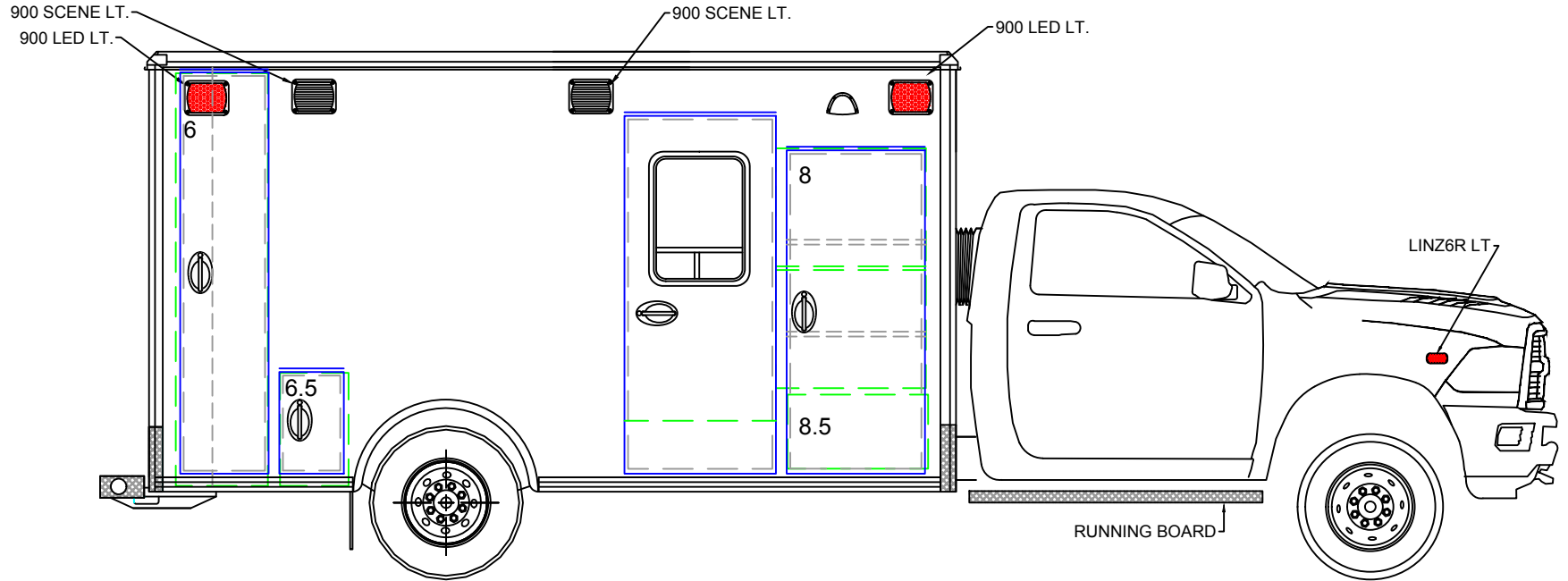

BE ADVISED THAT THESE ARE PRELIMINARY LAYOUTS INTENDED TO ILLUSTRATE DESIGN INTENT AND DIMENSIONS ARE FOR REFERENCE ONLY PRIOR TO FINAL ENGINEERING

EXTERIOR COMPARTMENT DIMENSIONS IN INCHES

INTERIOR DIMENSIONS				JAMB OPENING		INTERIOR DIMENSIONS				JAMB OPENING	
COMPT.	HEIGHT	WIDTH	DEPTH	HEIGHT	WIDTH	COMPT.	HEIGHT	WIDTH	DEPTH	HEIGHT	WIDTH
8				65.50	27.25						
8.5	15.50	30.50	19.00								
6.5	22.50	14.25	17.00	19.25	12.00						
6	85.00	19.00	18.50	82.00	17.00						



TYPE 1 DODGE
RIGHT EXT. VIEW

DATE 3/5/21

SCALE

DRAWN BY AP

DWG NO 3 / 9

50" AISLE

CA111117

MODEL 1170D

170 x 95 x 72

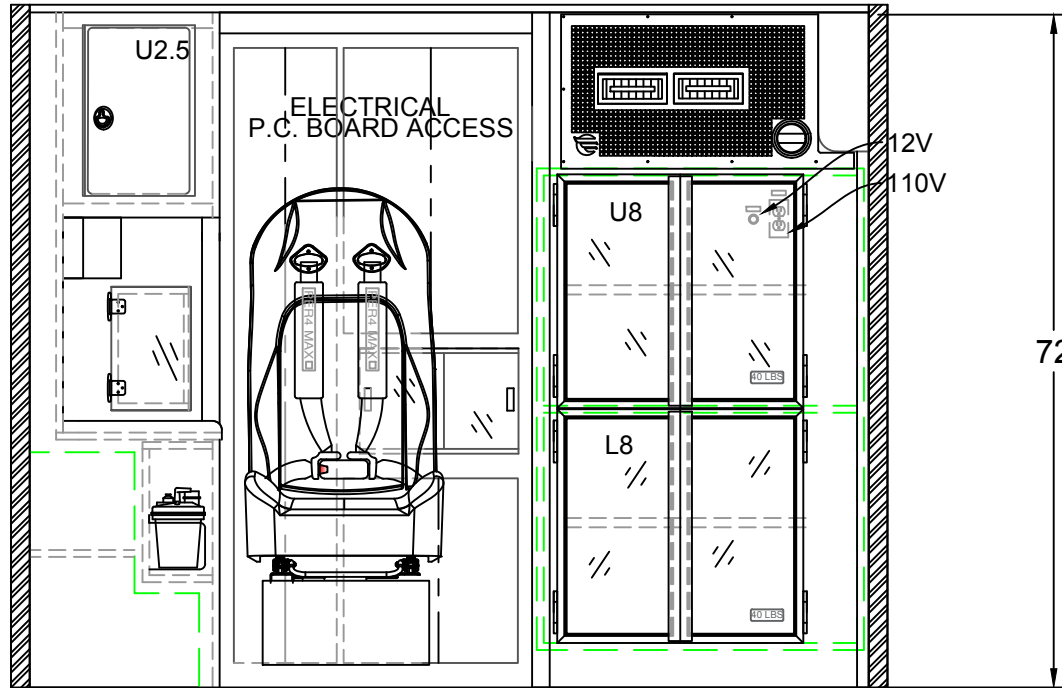

BE ADVISED THAT THESE ARE PRELIMINARY LAYOUTS INTENDED TO ILLUSTRATE DESIGN INTENT AND DIMENSIONS ARE FOR REFERENCE ONLY PRIOR TO FINAL ENGINEERING

<p><u>CABINET WEIGHT RATINGS:</u> NON-RESTOCKING = 40 LBS. RESTOCKING = 30 LBS.</p>	<p>INTERIOR CABINET DIMENSIONS IN INCHES</p>							 <p>TYPE 1 DODGE BULKHEAD INTERIOR</p>		
	CABINET	HEIGHT	WIDTH	DEPTH	CABINET	HEIGHT	WIDTH			DEPTH
	U8	24.50	33.50	30.50						
	L8	24.50	33.50	30.50						
									DATE	SCALE
									3/5/21	
									DRAWN BY	DWG NO
									AP	4 / 9

50" AISLE

CA111117

MODEL 1170D

170 x 95 x 72

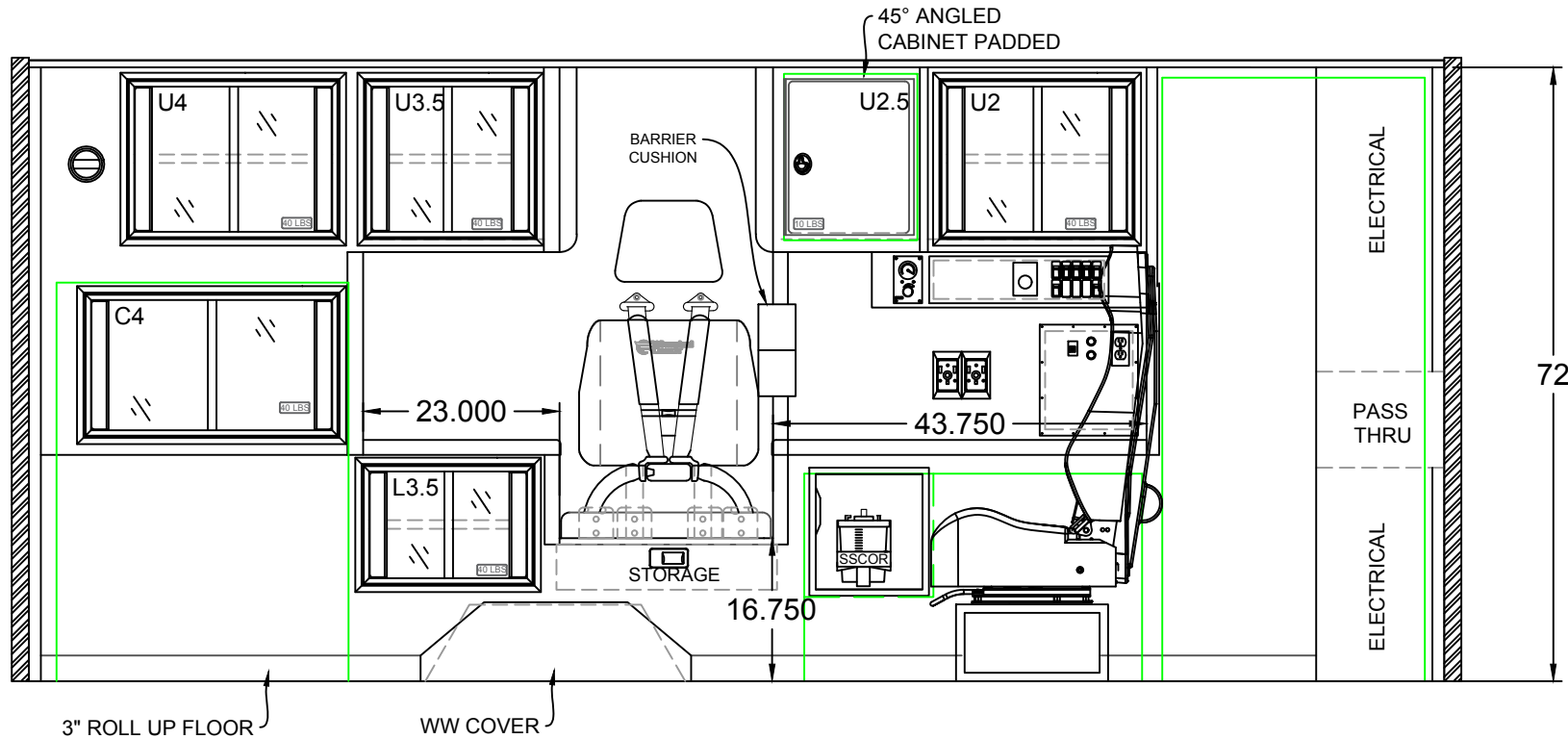

INTERIOR CABINET DIMENSIONS IN INCHES

CABINET	HEIGHT	WIDTH	DEPTH		CABINET	HEIGHT	WIDTH	DEPTH	
C4	17.00	30.00	IS/OS		CPR	4.50	23.50	18.25	
U4	18.75	26.25	18.25		L3.5	14.25	20.25	18.25	
U3.5	18.75	20.25	18.25						
U2.5	19.50	18.00	16.00						
U2	18.75	24.25	16.00						



TYPE 1 DODGE

LEFT INTERIOR

50" AISLE

CABINET WEIGHT RATINGS:
NON-RESTOCKING = 40 LBS.
RESTOCKING = 30 LBS.

BE ADVISED THAT THESE ARE PRELIMINARY LAYOUTS INTENDED TO ILLUSTRATE DESIGN INTENT AND DIMENSIONS ARE FOR REFERENCE ONLY PRIOR TO FINAL ENGINEERING

DATE:	3/5/21	SCALE:	
DWN BY:	AP	DWG NO:	5 / 9

CA111117

MODEL 1170D

170 x 95 x 72

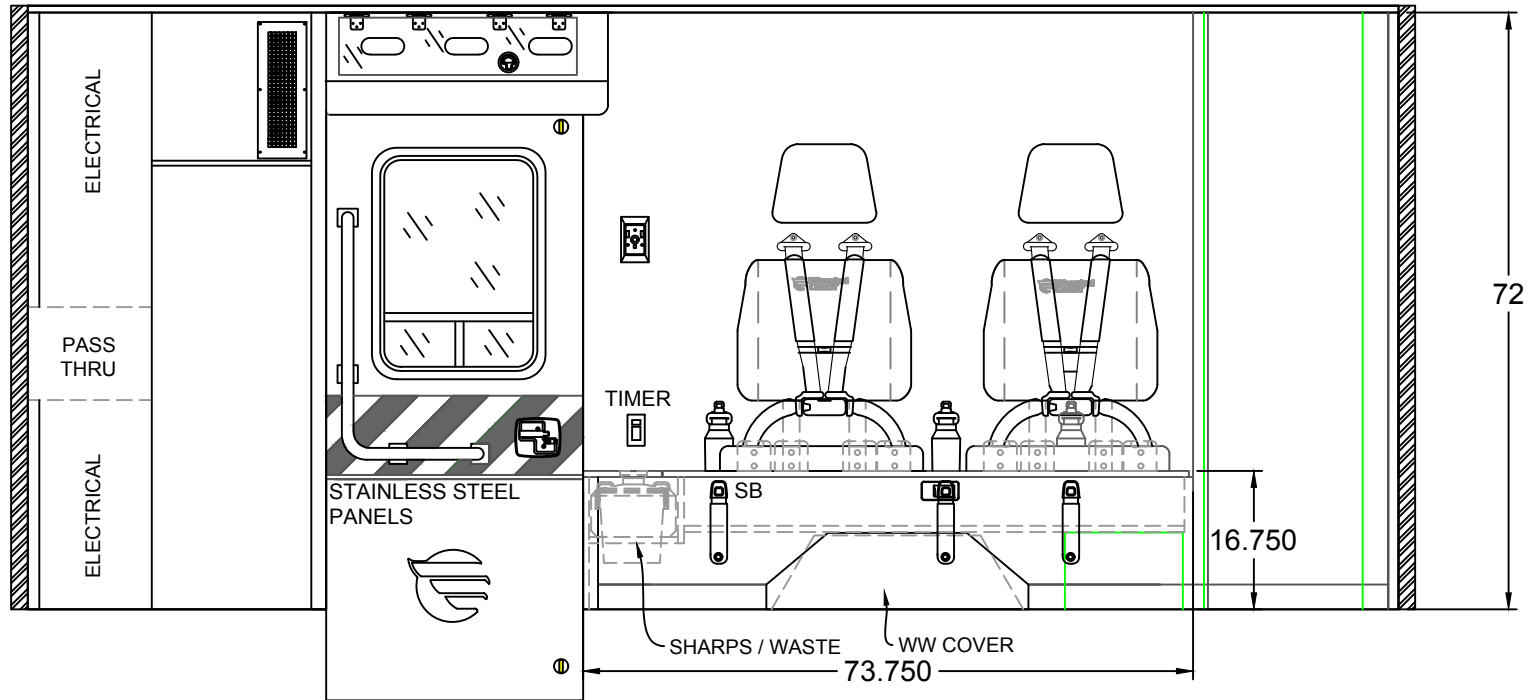

INTERIOR CABINET DIMENSIONS IN INCHES

COMPT.	HEIGHT	WIDTH	DEPTH	COMPT.	HEIGHT	WIDTH	DEPTH
SB	5.75	60.75	16.75				

50" AISLE

CABINET WEIGHT RATINGS:
NON-RESTOCKING = 40 LBS.
RESTOCKING = 30 LBS.

BE ADVISED THAT THESE ARE PRELIMINARY LAYOUTS INTENDED TO ILLUSTRATE DESIGN INTENT AND DIMENSIONS ARE FOR REFERENCE ONLY PRIOR TO FINAL ENGINEERING



TYPE 1 DODGE
RIGHT INTERIOR

DATE: 3/5/21

SCALE

DRAWN BY: AP

DWG NO: 6 / 9

CA111117

MODEL 1170D

170 x 95 x 72

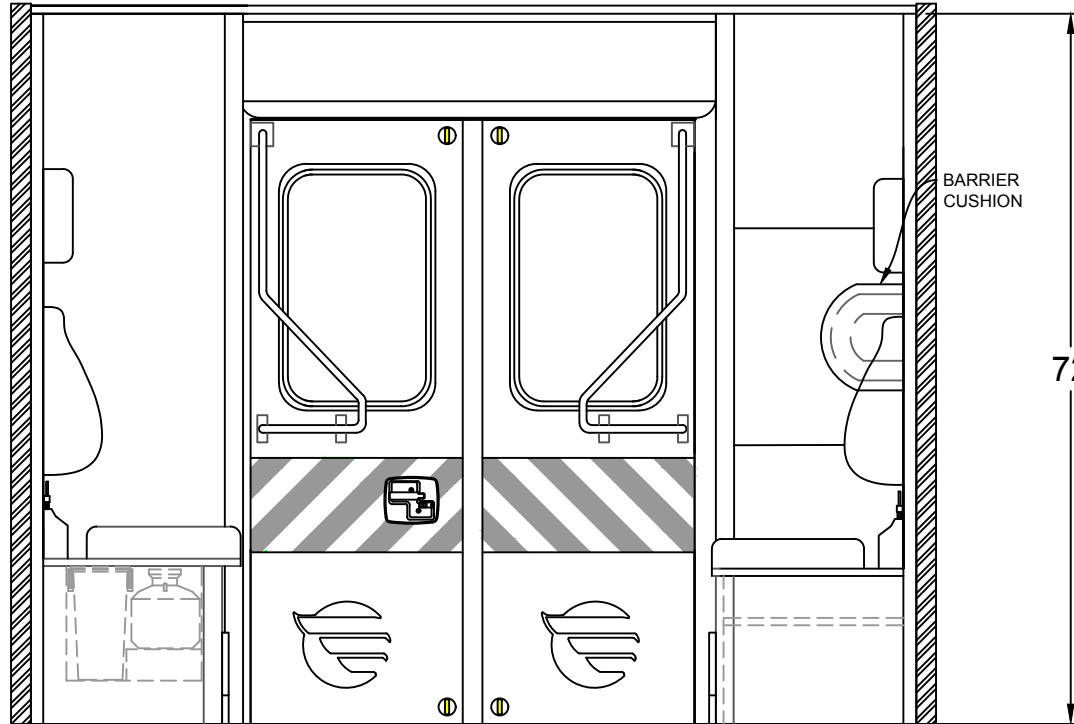

INTERIOR CABINET DIMENSIONS IN INCHES

COMPT.	HEIGHT	WIDTH	DEPTH		COMPT.	HEIGHT	WIDTH	DEPTH	

50" AISLE

CABINET WEIGHT RATINGS:
NON-RESTOCKING = 40 LBS.
RESTOCKING = 30 LBS.

BE ADVISED THAT THESE ARE PRELIMINARY LAYOUTS INTENDED TO ILLUSTRATE DESIGN INTENT AND DIMENSIONS ARE FOR REFERENCE ONLY PRIOR TO FINAL ENGINEERING



TYPE 1 DODGE

REAR BULKHEAD INTERIOR

DATE: 3/5/21

SCALE

DWGN BY: AP

DWG NO: 7 / 9

CA111117

MODEL 1170D

170 x 95 x 72

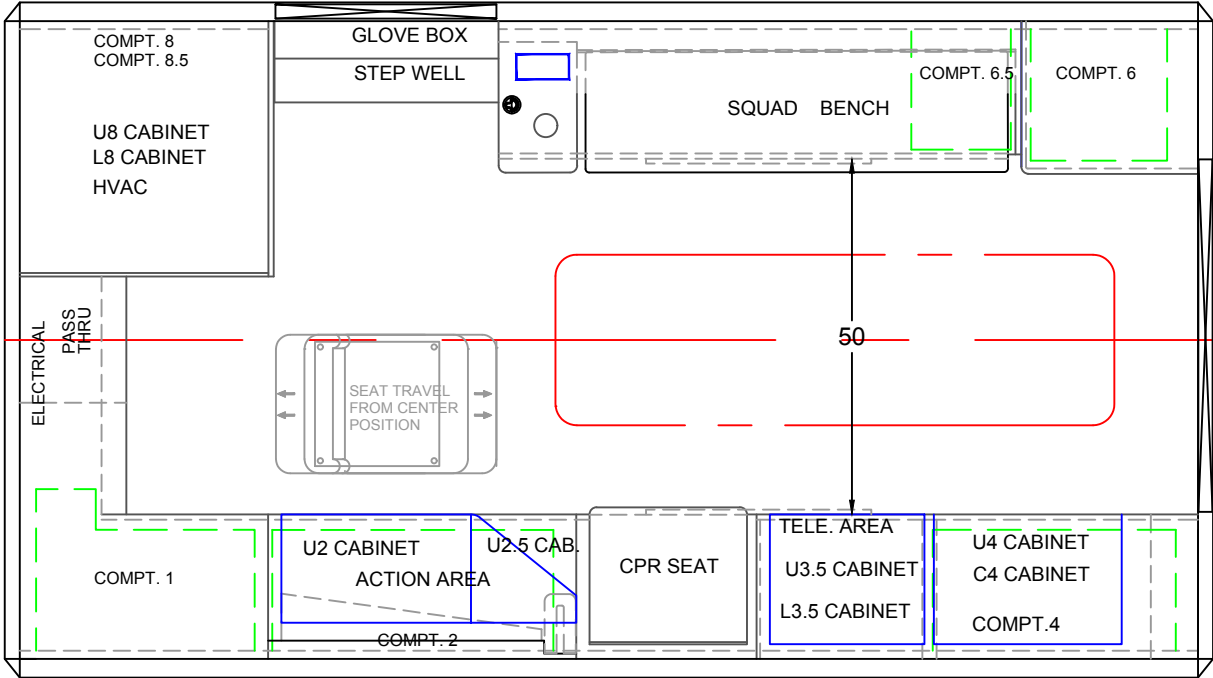

BE ADVISED THAT THESE ARE PRELIMINARY LAYOUTS INTENDED TO ILLUSTRATE DESIGN INTENT AND DIMENSIONS ARE FOR REFERENCE ONLY PRIOR TO FINAL ENGINEERING

INTERIOR CABINET DIMENSIONS IN INCHES									
CABINET	HEIGHT	WIDTH	DEPTH	CABINET	HEIGHT	WIDTH	DEPTH		
								TYPE 1 DODGE FLOOR PLAN	
50" AISLE								DATE: 3/5/21 DWN BY: AP	SCALE: DWG NO: 8 / 9

CA111117

MODEL 1170D

170 x 95 x 72

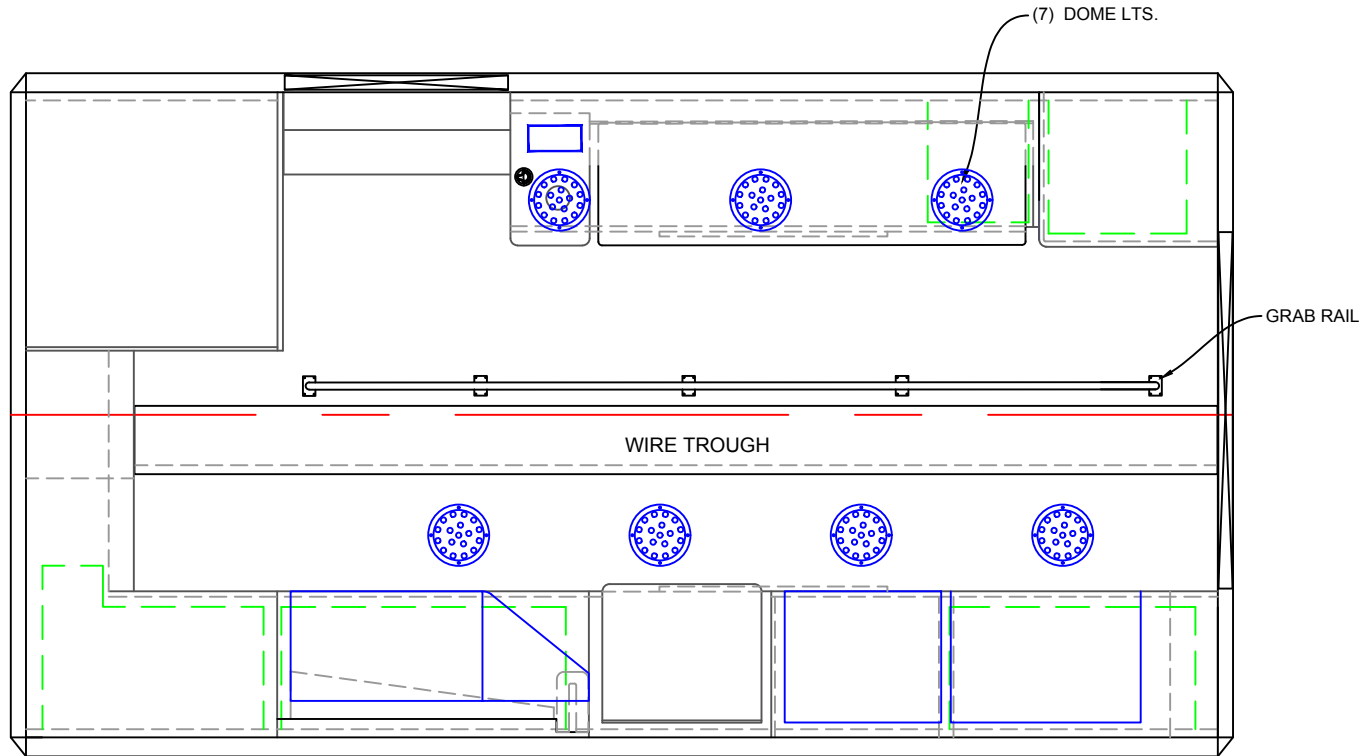

BE ADVISED THAT THESE ARE PRELIMINARY LAYOUTS INTENDED TO ILLUSTRATE DESIGN INTENT AND DIMENSIONS ARE FOR REFERENCE ONLY PRIOR TO FINAL ENGINEERING

INTERIOR CABINET DIMENSIONS IN INCHES

CABINET	HEIGHT	WIDTH	DEPTH	CABINET	HEIGHT	WIDTH	DEPTH



TYPE 1 DODGE
LINER

DATE: 3/5/21

SCALE

DWN BY AP

DWG NO 9 / 9

50" AISLE