

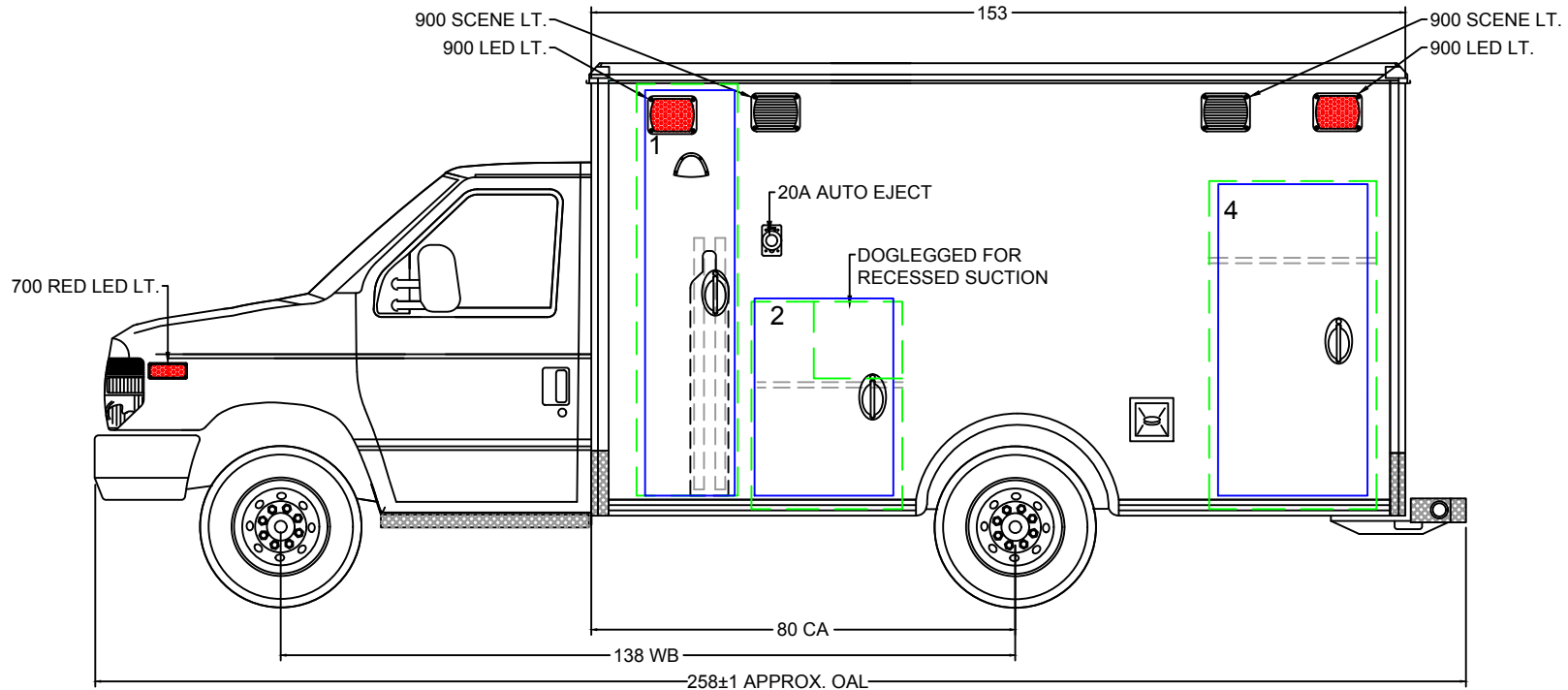

CA151496

MODEL 3153F

153 x 95 x 67



BE ADVISED THAT THESE ARE PRELIMINARY LAYOUTS INTENDED TO ILLUSTRATE DESIGN INTENT AND DIMENSIONS ARE FOR REFERENCE ONLY PRIOR TO FINAL ENGINEERING

EXTERIOR COMPARTMENT DIMENSIONS IN INCHES												
INTERIOR DIMENSIONS				JAMB OPENING		INTERIOR DIMENSIONS				JAMB OPENING		
COMPT.	HEIGHT	WIDTH	DEPTH	HEIGHT	WIDTH	COMPT.	HEIGHT	WIDTH	DEPTH	HEIGHT	WIDTH	
4	61.50	31.50	17.00	58.50	28.00							
2	39.00	28.50	17.00	37.00	26.00							
1	77.50	19.00	17.00	76.75	17.00							
50" AISLE												DATE 3/4/21 DRAWN BY AP
												SCALE DWG NO 2 / 9



TYPE 3 FORD

LEFT EXT. VIEW

DATE 3/4/21

DRAWN BY AP

SCALE

DWG NO

2 / 9

CA151496

MODEL 3153F

153 x 95 x 67

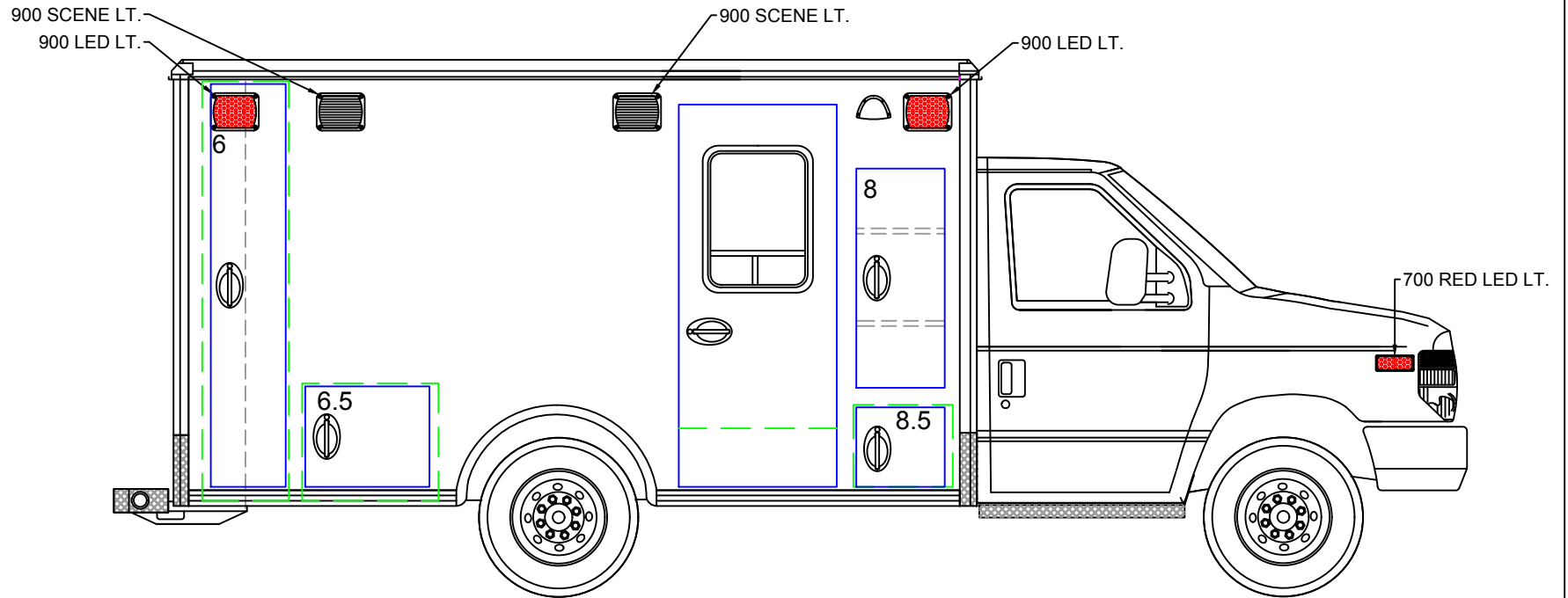

BE ADVISED THAT THESE ARE PRELIMINARY LAYOUTS INTENDED TO ILLUSTRATE DESIGN INTENT AND DIMENSIONS ARE FOR REFERENCE ONLY PRIOR TO FINAL ENGINEERING

EXTERIOR COMPARTMENT DIMENSIONS IN INCHES

INTERIOR DIMENSIONS				JAMB OPENING		INTERIOR DIMENSIONS				JAMB OPENING	
COMPT.	HEIGHT	WIDTH	DEPTH	HEIGHT	WIDTH	COMPT.	HEIGHT	WIDTH	DEPTH	HEIGHT	WIDTH
8				41.75	16.75						
8.5	15.50	19.00	18.75	15.00	16.75						
6.5	22.50	26.00	15.50	19.50	23.50						
6	80.00	16.50	18.25	76.75	14.25						



TYPE 3 FORD

RIGHT EXT. VIEW

DATE 3/4/21

SCALE

DRAWN BY AP

DWG NO 3 / 9

50" AISLE

CA151496

MODEL 3153F

153 x 95 x 67

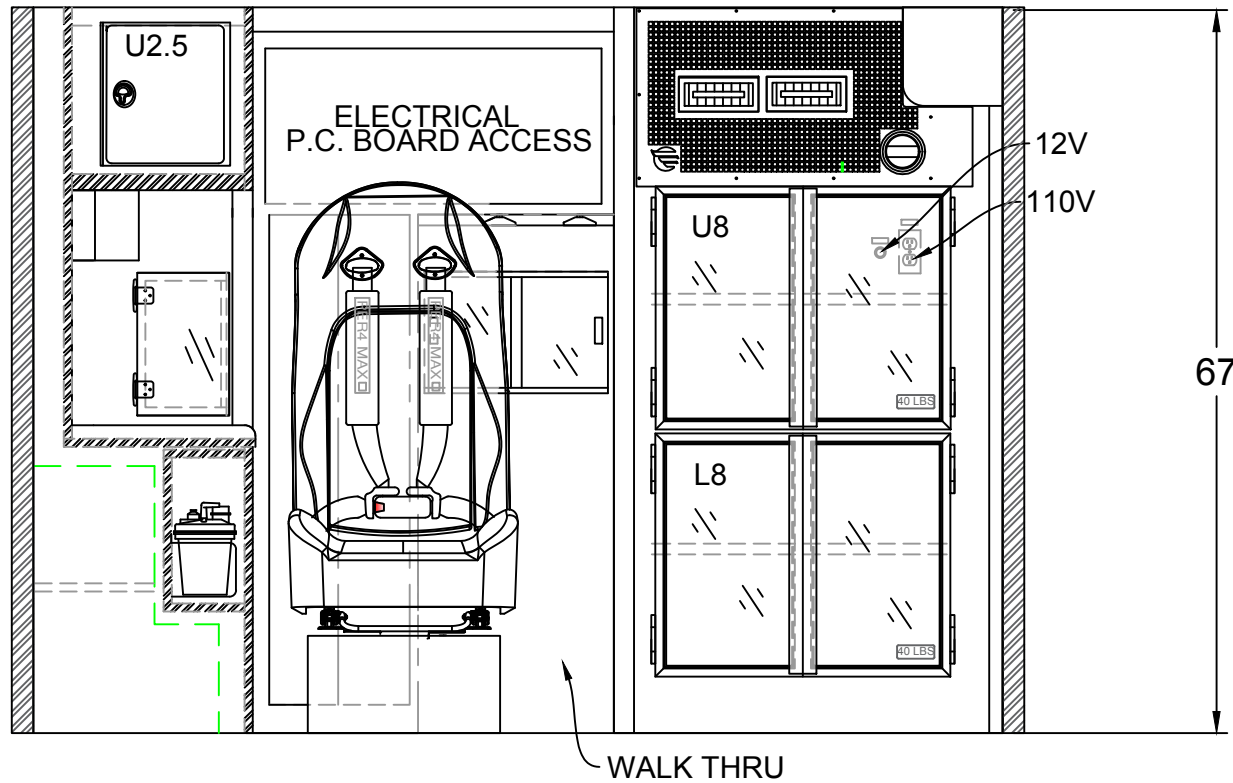

BE ADVISED THAT THESE ARE PRELIMINARY LAYOUTS INTENDED TO ILLUSTRATE DESIGN INTENT AND DIMENSIONS ARE FOR REFERENCE ONLY PRIOR TO FINAL ENGINEERING

<p>CABINET WEIGHT RATINGS: NON-RESTOCKING = 40 LBS. RESTOCKING = 30 LBS.</p>	<p>INTERIOR CABINET DIMENSIONS IN INCHES</p>									
	CABINET	HEIGHT	WIDTH	DEPTH	CABINET	HEIGHT	WIDTH	DEPTH		<p>TYPE 3 FORD BULKHEAD INTERIOR</p>
	U8	22.00	33.50	19.00						
	L8	22.00	33.50	19.00						
50" AISLE								<p>DATE 3/4/21</p>	<p>SCALE</p>	
								<p>DRAWN BY AP</p>	<p>DWG NO 4 / 9</p>	

CA151496

MODEL 3153F

153 x 95 x 67

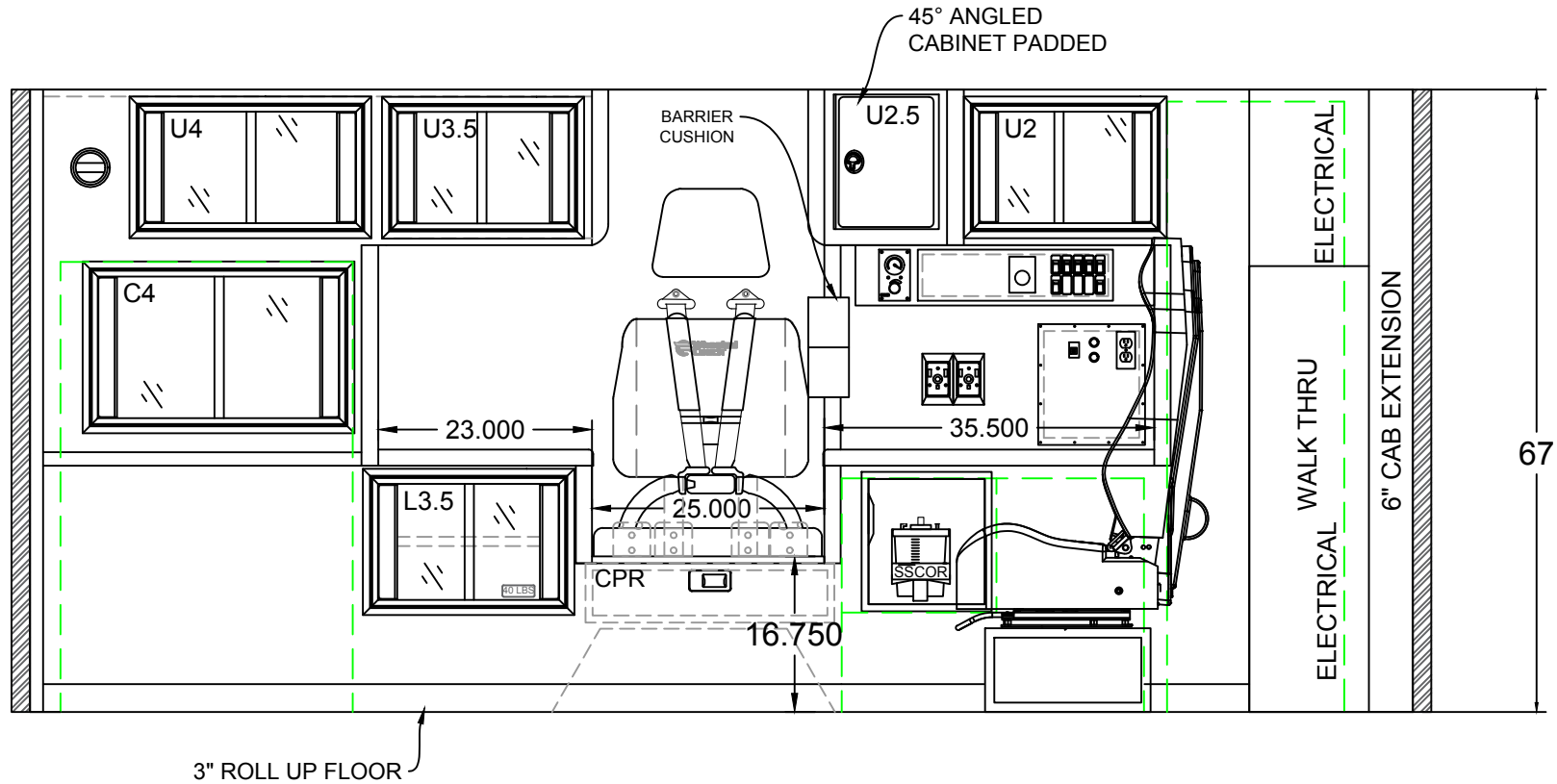

INTERIOR CABINET DIMENSIONS IN INCHES

CABINET	HEIGHT	WIDTH	DEPTH		CABINET	HEIGHT	WIDTH	DEPTH	
C4	17.00	27.25	IS/OS		U2	13.75	20.25	15.25	
U4	13.75	24.50	17.50		L3.5	14.25	20.25	17.50	
U3.5	13.75	20.25	17.50		CPR	4.50	23.50	17.50	
U2.5	14.50	13.50	15.25						



TYPE 3 FORD

LEFT INTERIOR

50" AISLE

CABINET WEIGHT RATINGS:
NON-RESTOCKING = 40 LBS.
RESTOCKING = 30 LBS.

BE ADVISED THAT THESE ARE PRELIMINARY LAYOUTS INTENDED TO ILLUSTRATE DESIGN INTENT AND DIMENSIONS ARE FOR REFERENCE ONLY PRIOR TO FINAL ENGINEERING

DATE:	3/4/21	SCALE:	
DWN BY:	AP	DWG NO:	5 / 9

CA151496

MODEL 3153F

153 x 95 x 67

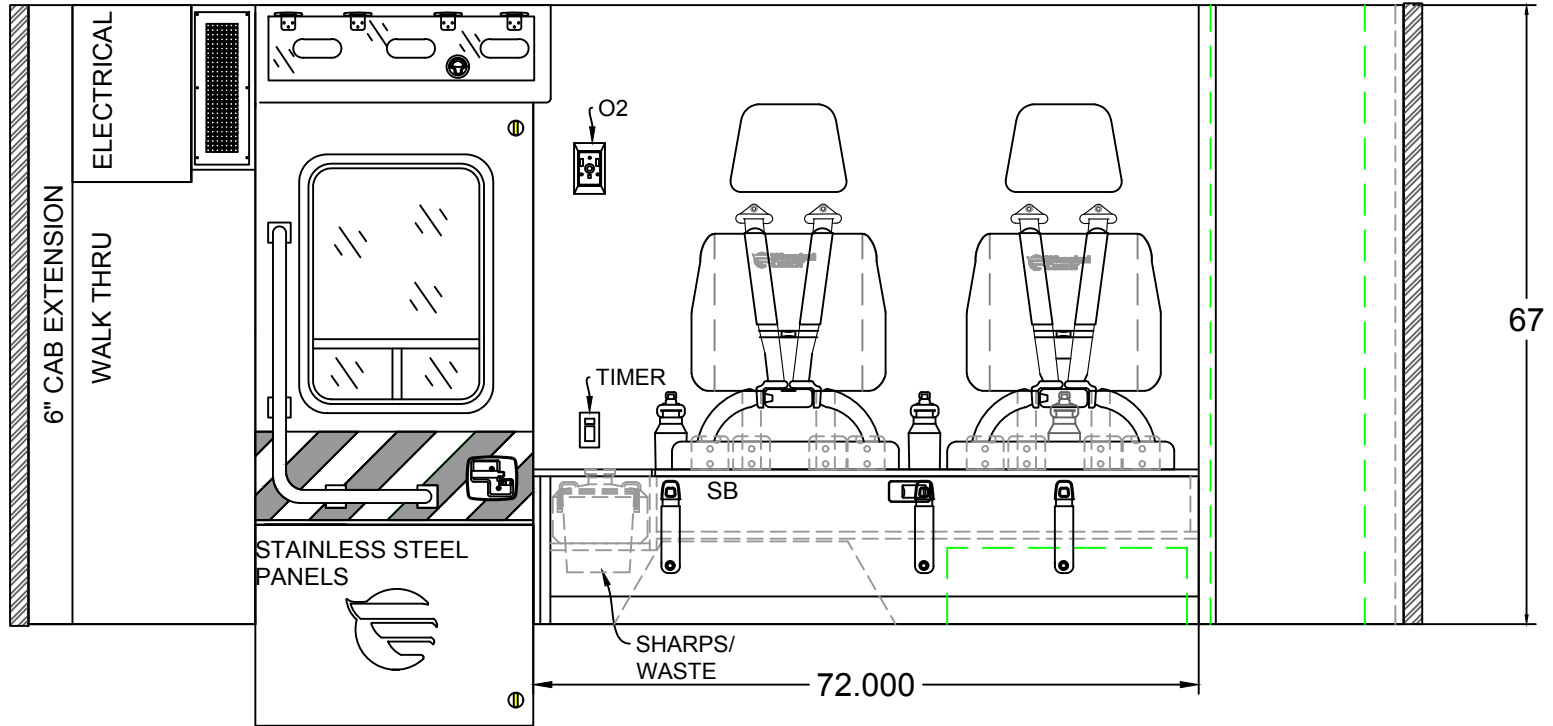

INTERIOR CABINET DIMENSIONS IN INCHES

COMPT.	HEIGHT	WIDTH	DEPTH	COMPT.	HEIGHT	WIDTH	DEPTH
SB	6.00	57.75	16.75				

50" AISLE

CABINET WEIGHT RATINGS:
NON-RESTOCKING = 40 LBS.
RESTOCKING = 30 LBS.

BE ADVISED THAT THESE ARE PRELIMINARY LAYOUTS INTENDED TO ILLUSTRATE DESIGN INTENT AND DIMENSIONS ARE FOR REFERENCE ONLY PRIOR TO FINAL ENGINEERING



TYPE 3 FORD
RIGHT INTERIOR

DATE: 3/4/21	SCALE
DRAWN BY: AP	DWG NO: 6 / 9

CA151496

MODEL 3153F

153 x 95 x 67

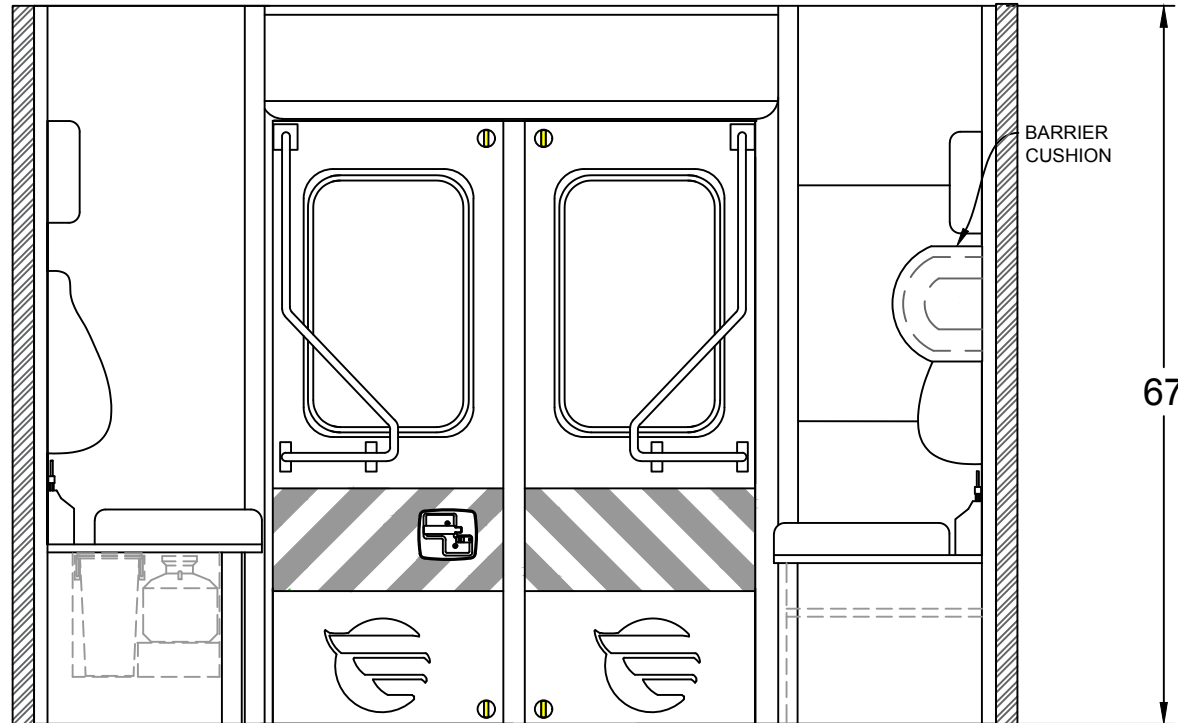

INTERIOR CABINET DIMENSIONS IN INCHES



COMPT.	HEIGHT	WIDTH	DEPTH		COMPT.	HEIGHT	WIDTH	DEPTH	

TYPE 3 FORD
REAR BULKHEAD INTERIOR

DATE: 3/4/21 SCALE

DWGN BY: AP DWGS NO: 7 / 9

50" AISLE

CABINET WEIGHT RATINGS:
NON-RESTOCKING = 40 LBS.
RESTOCKING = 30 LBS.

BE ADVISED THAT THESE ARE PRELIMINARY LAYOUTS INTENDED TO ILLUSTRATE DESIGN INTENT AND DIMENSIONS ARE FOR REFERENCE ONLY PRIOR TO FINAL ENGINEERING

CA151496

MODEL 3153F

153 x 95 x 67

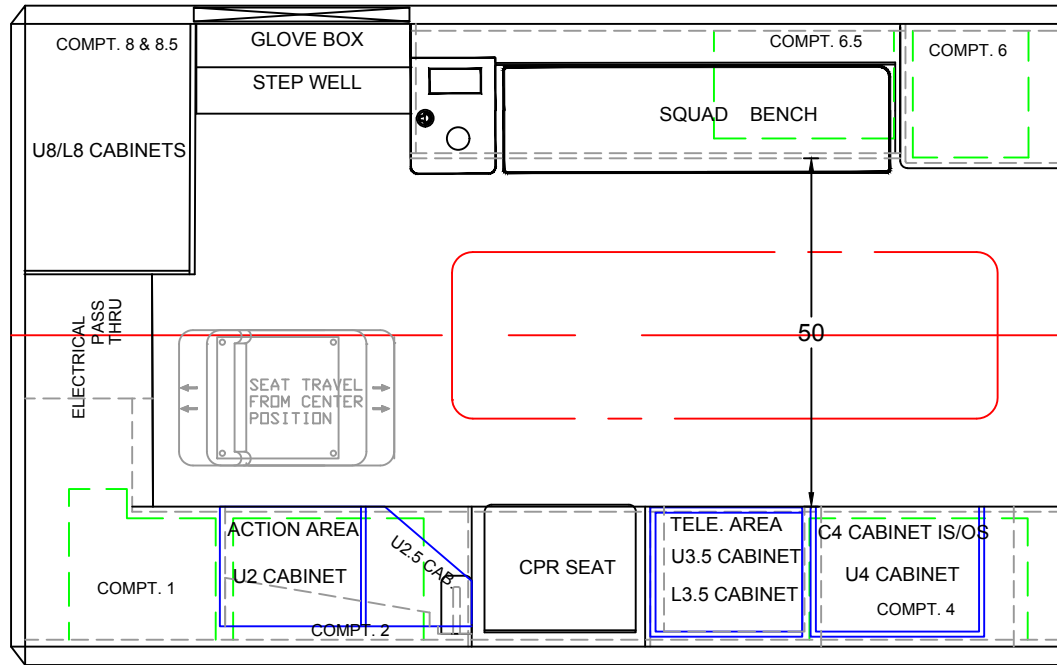

BE ADVISED THAT THESE ARE PRELIMINARY LAYOUTS INTENDED TO ILLUSTRATE DESIGN INTENT AND DIMENSIONS ARE FOR REFERENCE ONLY PRIOR TO FINAL ENGINEERING

INTERIOR CABINET DIMENSIONS IN INCHES

CABINET	HEIGHT	WIDTH	DEPTH	CABINET	HEIGHT	WIDTH	DEPTH



TYPE 3 FORD
FLOOR PLAN

DATE: 3/4/21

SCALE

DWN BY: AP

DWG NO: 8 / 9

50" AISLE

CA151496

MODEL 3153F

153 x 95 x 67

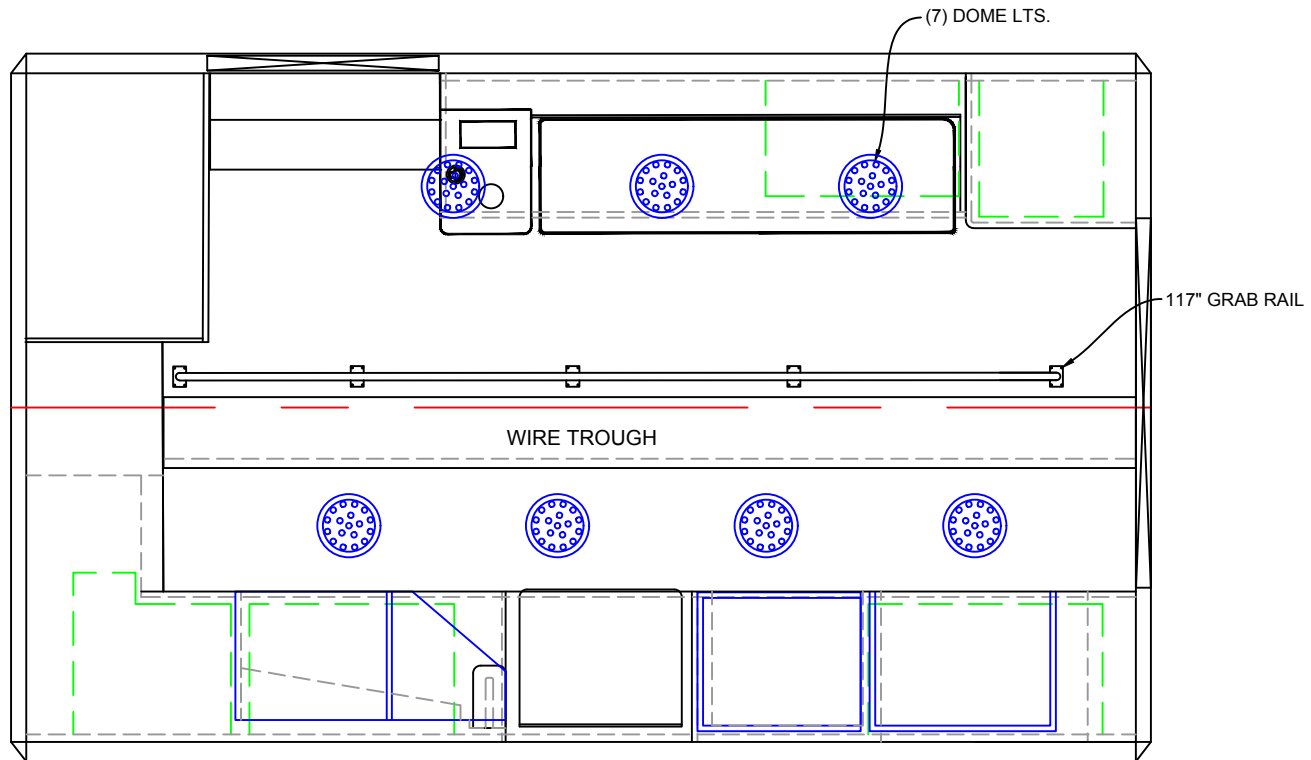

BE ADVISED THAT THESE ARE PRELIMINARY LAYOUTS INTENDED TO ILLUSTRATE DESIGN INTENT AND DIMENSIONS ARE FOR REFERENCE ONLY PRIOR TO FINAL ENGINEERING

INTERIOR CABINET DIMENSIONS IN INCHES

CABINET	HEIGHT	WIDTH	DEPTH	CABINET	HEIGHT	WIDTH	DEPTH



TYPE 3 FORD
LINER

DATE: 3/4/21 SCALE:
DWN BY: AP DWG NO: 9 / 9

50" AISLE