

CA101242

MODEL 3148F CITIMEDIC

148 x 90 x 68

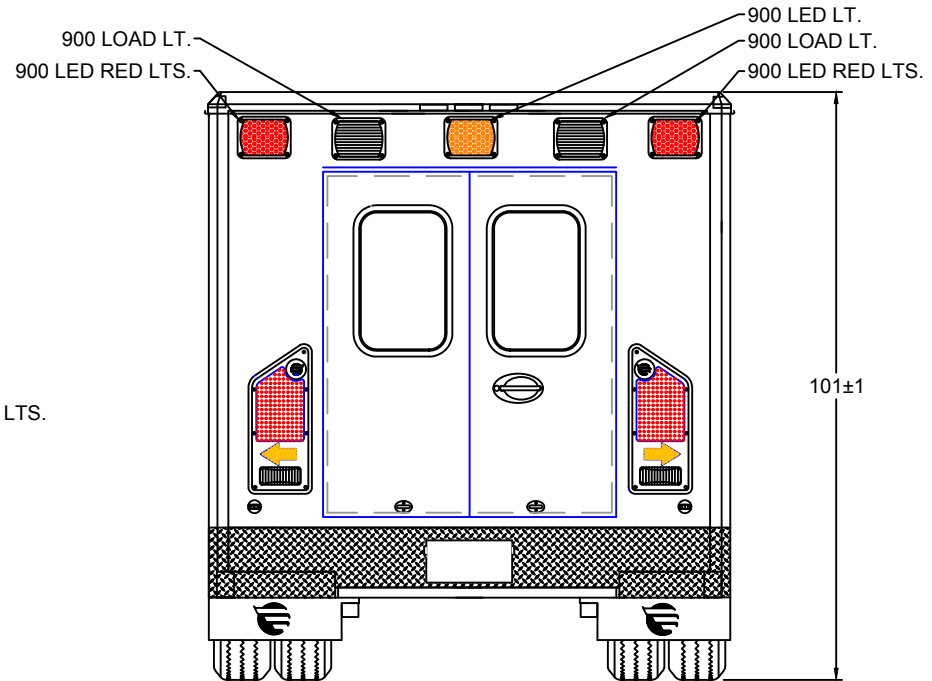
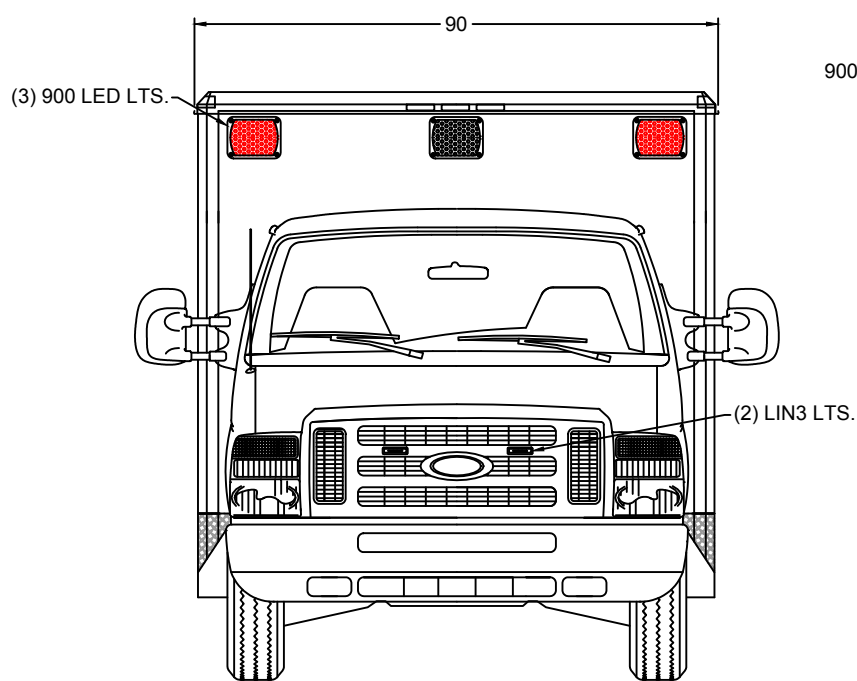

EXTERIOR COMPARTMENT DIMENSIONS IN INCHES

INTERIOR DIMENSIONS				PASS THRU		INTERIOR DIMENSIONS				JAMB OPENING	
COMPT.	HEIGHT	WIDTH	DEPTH	HEIGHT	WIDTH	COMPT.	HEIGHT	WIDTH	DEPTH	HEIGHT	WIDTH



E-350 TYPE 3 FORD 2021
FRONT / REAR
EXTERIOR VIEWS

BE ADVISED THAT THESE ARE PRELIMINARY LAYOUTS INTENDED TO ILLUSTRATE DESIGN INTENT AND DIMENSIONS ARE FOR REFERENCE ONLY PRIOR TO FINAL ENGINEERING

DATE:	1/20/21	SCALE
DWN BY:	AP	DWG NO 1 / 12

49" AISLE

CA101242

MODEL 3148F CITIMEDIC

148 x 90 x 68

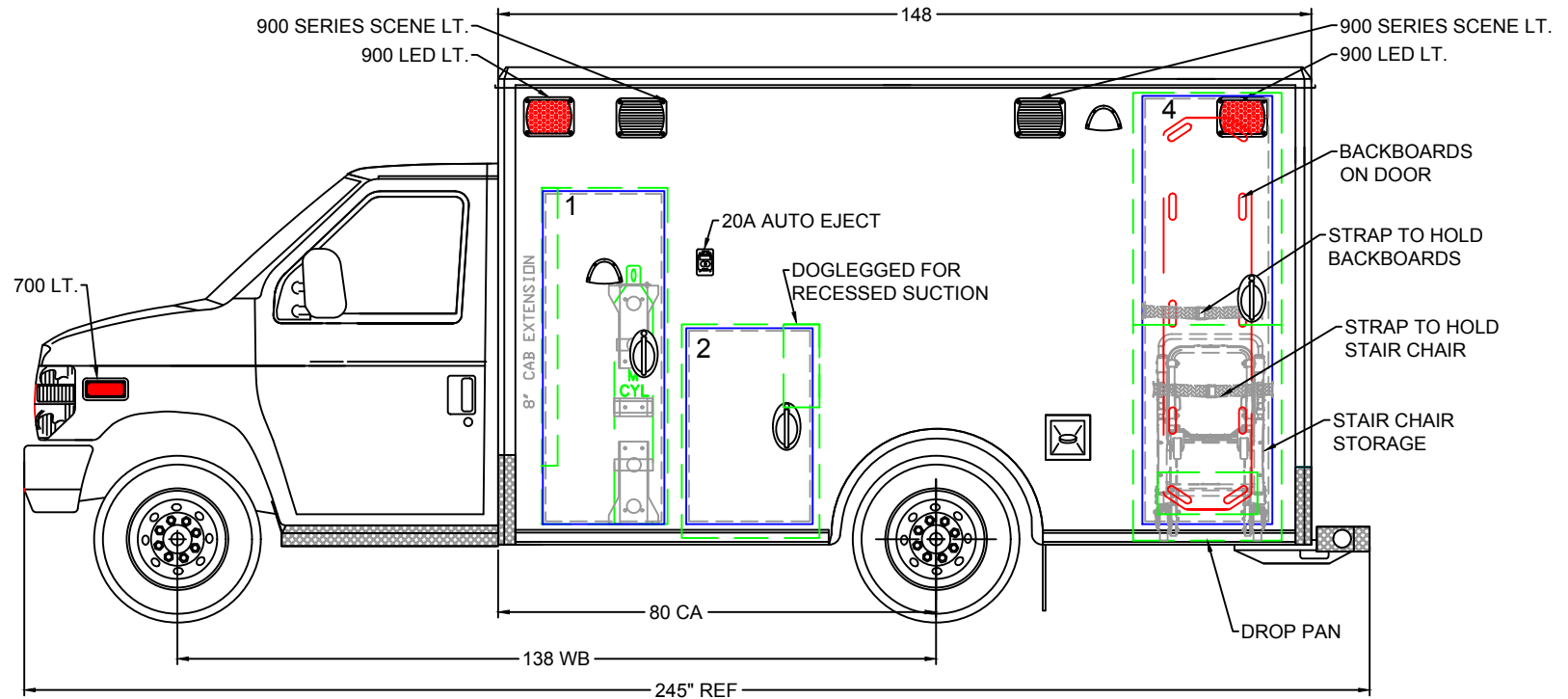

BE ADVISED THAT THESE ARE PRELIMINARY LAYOUTS INTENDED TO ILLUSTRATE DESIGN INTENT AND DIMENSIONS ARE FOR REFERENCE ONLY PRIOR TO FINAL ENGINEERING

EXTERIOR COMPARTMENT DIMENSIONS IN INCHES

INTERIOR DIMENSIONS				JAMB OPENING		INTERIOR DIMENSIONS				JAMB OPENING	
COMPT.	HEIGHT	WIDTH	DEPTH	HEIGHT	WIDTH	COMPT.	HEIGHT	WIDTH	DEPTH	HEIGHT	WIDTH
4	81.50	27.00	8.00/15.00	77.75	23.50						
2	38.75	25.00	15.00	35.75	22.75						
1	61.00	22.75	15.00	60.50	22.00						



E-350 TYPE 3 FORD 2021

LEFT EXT. VIEW

DATE 1/20/21

SCALE

DRAWN BY AP

DWG NO

2 / 12

49" AISLE

CA101242

MODEL 3148F CITIMEDIC

148 x 90 x 68

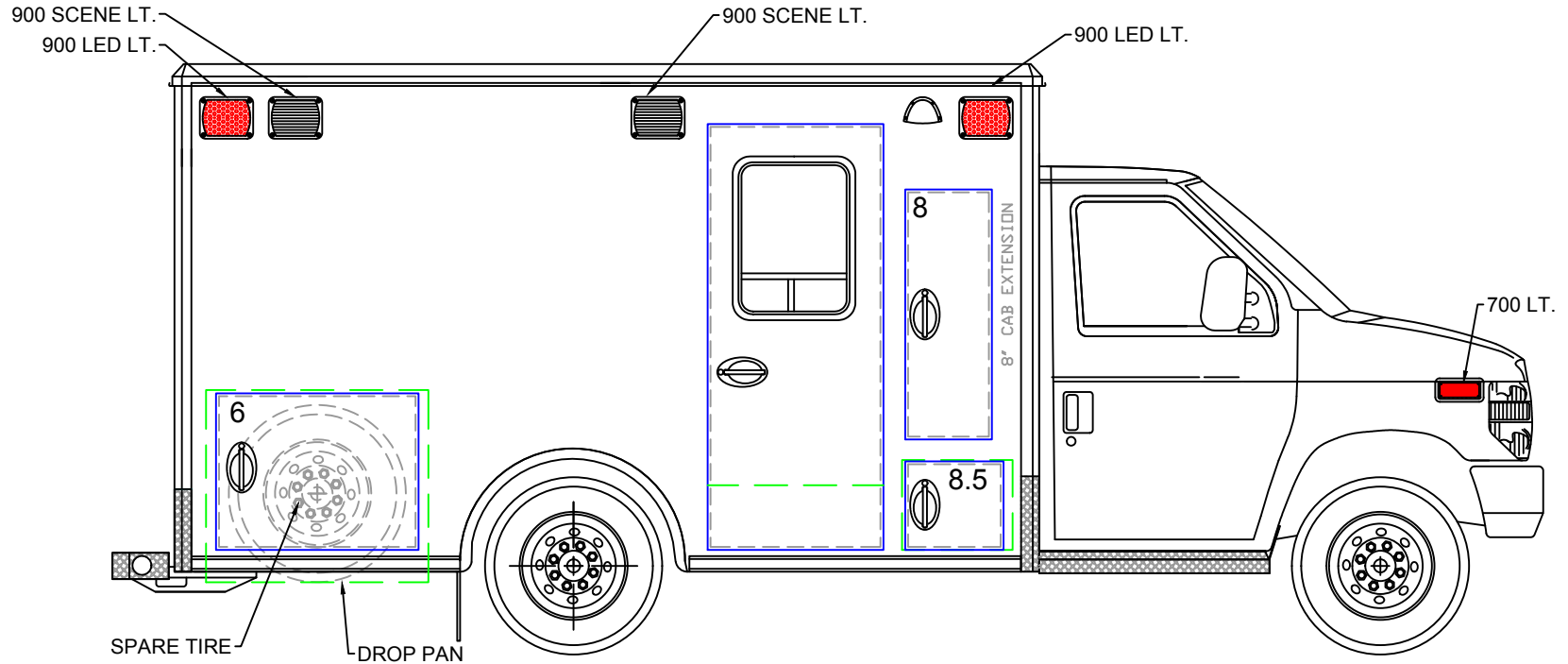

BE ADVISED THAT THESE ARE PRELIMINARY LAYOUTS INTENDED TO ILLUSTRATE DESIGN INTENT AND DIMENSIONS ARE FOR REFERENCE ONLY PRIOR TO FINAL ENGINEERING

EXTERIOR COMPARTMENT DIMENSIONS IN INCHES

INTERIOR DIMENSIONS				JAMB OPENING		INTERIOR DIMENSIONS				JAMB OPENING	
COMPT.	HEIGHT	WIDTH	DEPTH	HEIGHT	WIDTH	COMPT.	HEIGHT	WIDTH	DEPTH	HEIGHT	WIDTH
8				42.75	14.75						
6	32.75	38.00	15.50	26.75	34.50						
8.5	15.50	19.00	18.50	15.00	16.75						



E-350 TYPE 3 FORD 2021

RIGHT EXT. VIEW

DATE 1/20/21

SCALE

DRAWN BY AP

DWG NO 3 / 12

49" AISLE

CA101242

MODEL 3148F CITIMEDIC

148 x 90 x 68

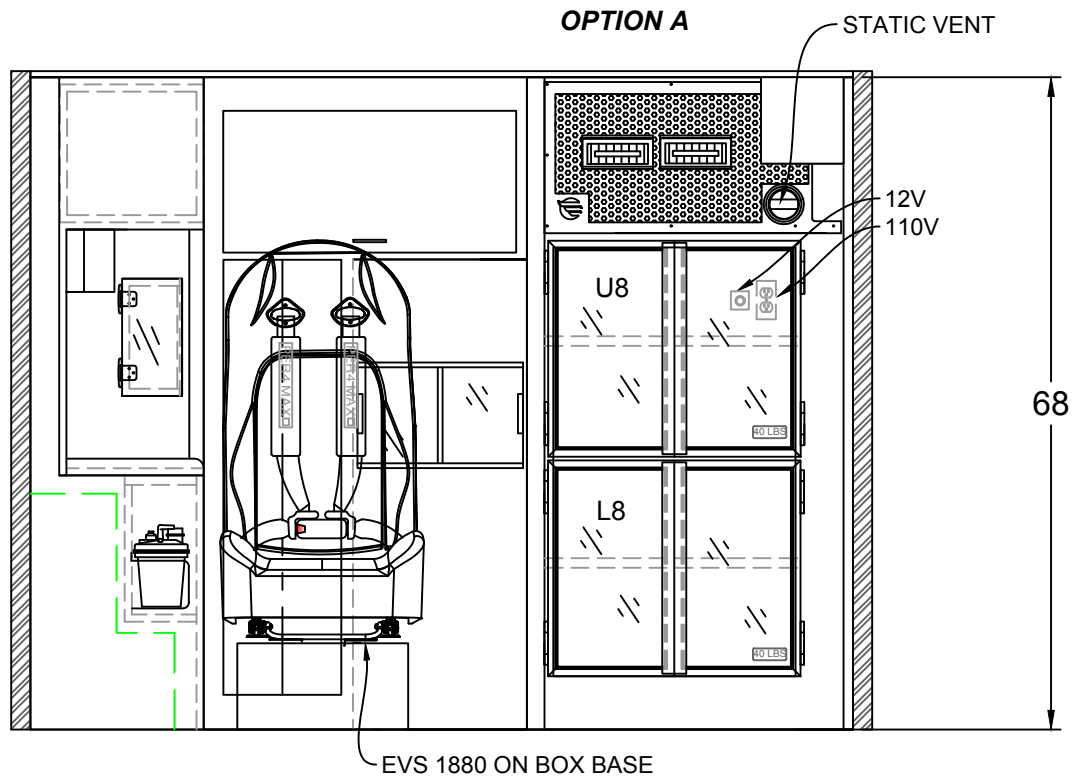

BE ADVISED THAT THESE ARE PRELIMINARY LAYOUTS INTENDED TO ILLUSTRATE DESIGN INTENT AND DIMENSIONS ARE FOR REFERENCE ONLY PRIOR TO FINAL ENGINEERING

INTERIOR CABINET DIMENSIONS IN INCHES										
CABINET	HEIGHT	WIDTH	DEPTH	CABINET	HEIGHT	WIDTH	DEPTH			
U8	22.50	31.50	14.75					E-350 TYPE 3 FORD 2021 BULKHEAD INTERIOR	DATE 1/20/21	SCALE
L8	22.50	31.50	14.75							
									DRAWN BY AP	DWG NO 4 / 12

49" AISLE

CA101242

MODEL 3148F CITIMEDIC

148 x 90 x 68

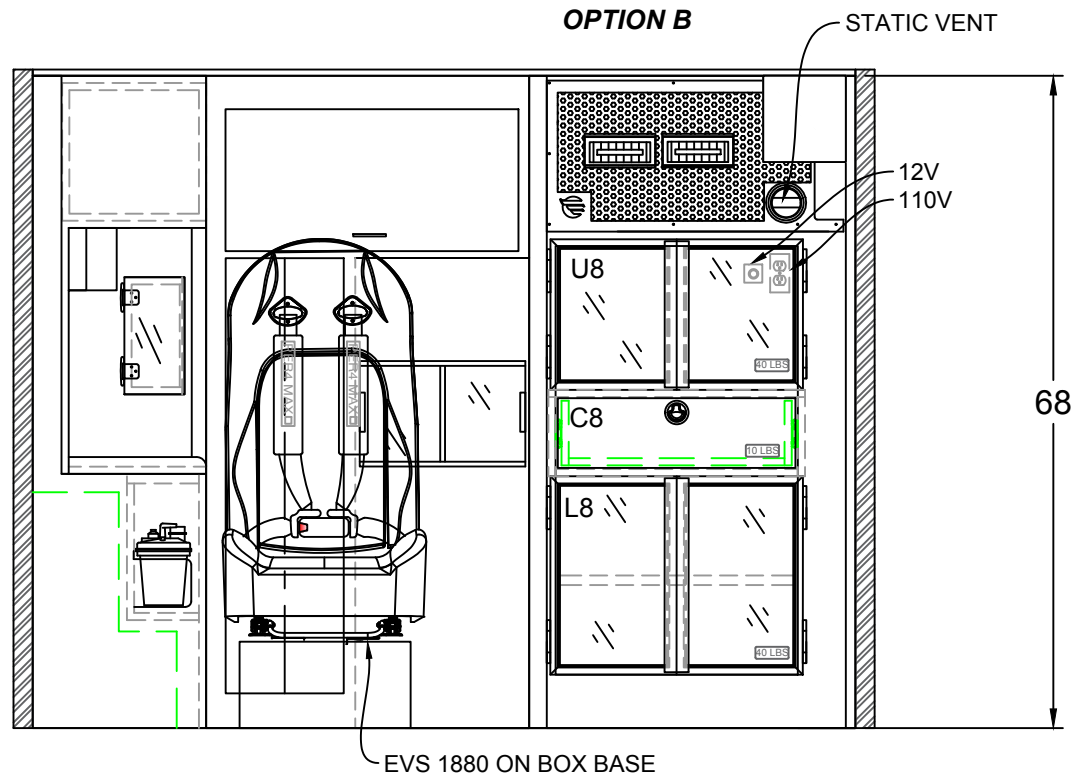

BE ADVISED THAT THESE ARE PRELIMINARY LAYOUTS INTENDED TO ILLUSTRATE DESIGN INTENT AND DIMENSIONS ARE FOR REFERENCE ONLY PRIOR TO FINAL ENGINEERING

INTERIOR CABINET DIMENSIONS IN INCHES									
CABINET	HEIGHT	WIDTH	DEPTH	CABINET	HEIGHT	WIDTH	DEPTH		
U8	15.00	31.50	14.75					E-350 TYPE 3 FORD 2021 BULKHEAD INTERIOR	
C8	6.00	22.50	13.25						
L8	20.50	31.50	14.75						
								DATE 1/20/21	SCALE
								DRAWN BY AP	DWG NO 5 / 12

49" AISLE

CA101242

MODEL 3148F CITIMEDIC

148 x 90 x 68

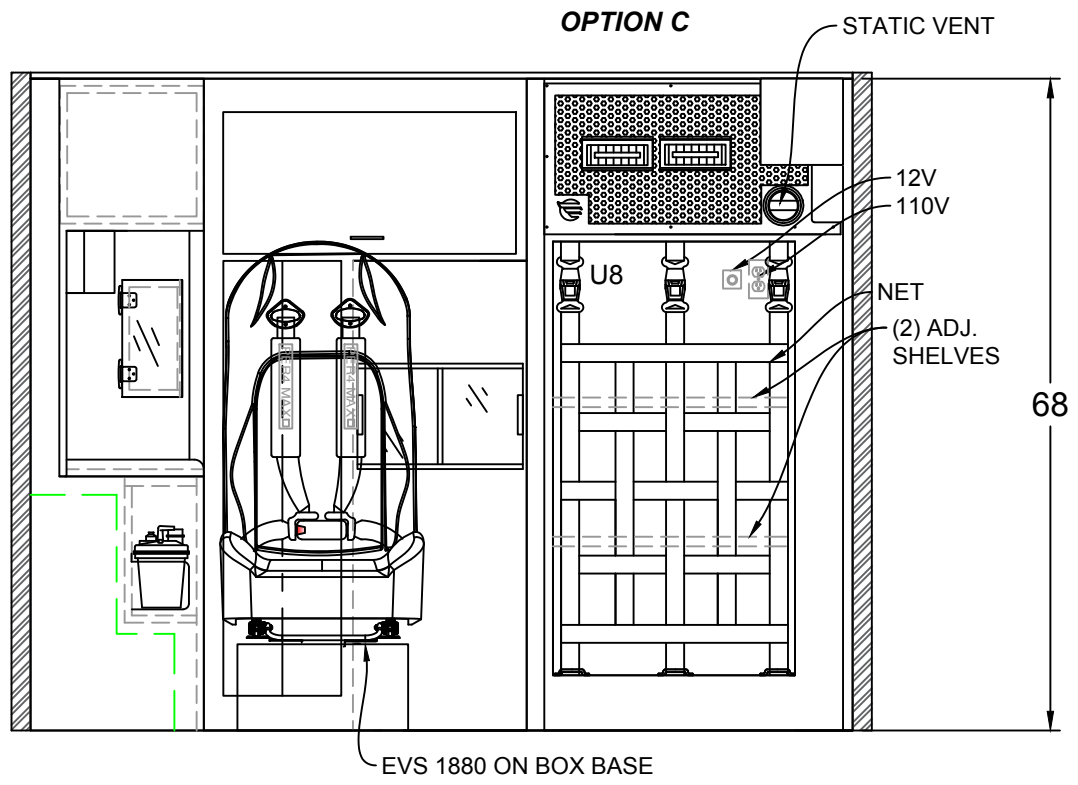

BE ADVISED THAT THESE ARE PRELIMINARY LAYOUTS INTENDED TO ILLUSTRATE DESIGN INTENT AND DIMENSIONS ARE FOR REFERENCE ONLY PRIOR TO FINAL ENGINEERING

INTERIOR CABINET DIMENSIONS IN INCHES											
CABINET	HEIGHT	WIDTH	DEPTH	CABINET	HEIGHT	WIDTH	DEPTH				
U8	46.00	31.50	14.75					E-350 TYPE 3 FORD 2021 BULKHEAD INTERIOR			
49" AISLE								DATE	1/20/21	SCALE	
								DRAWN BY	AP	DWG NO	6 / 12

CA101242

MODEL 3148F CITIMEDIC

148 x 90 x 68

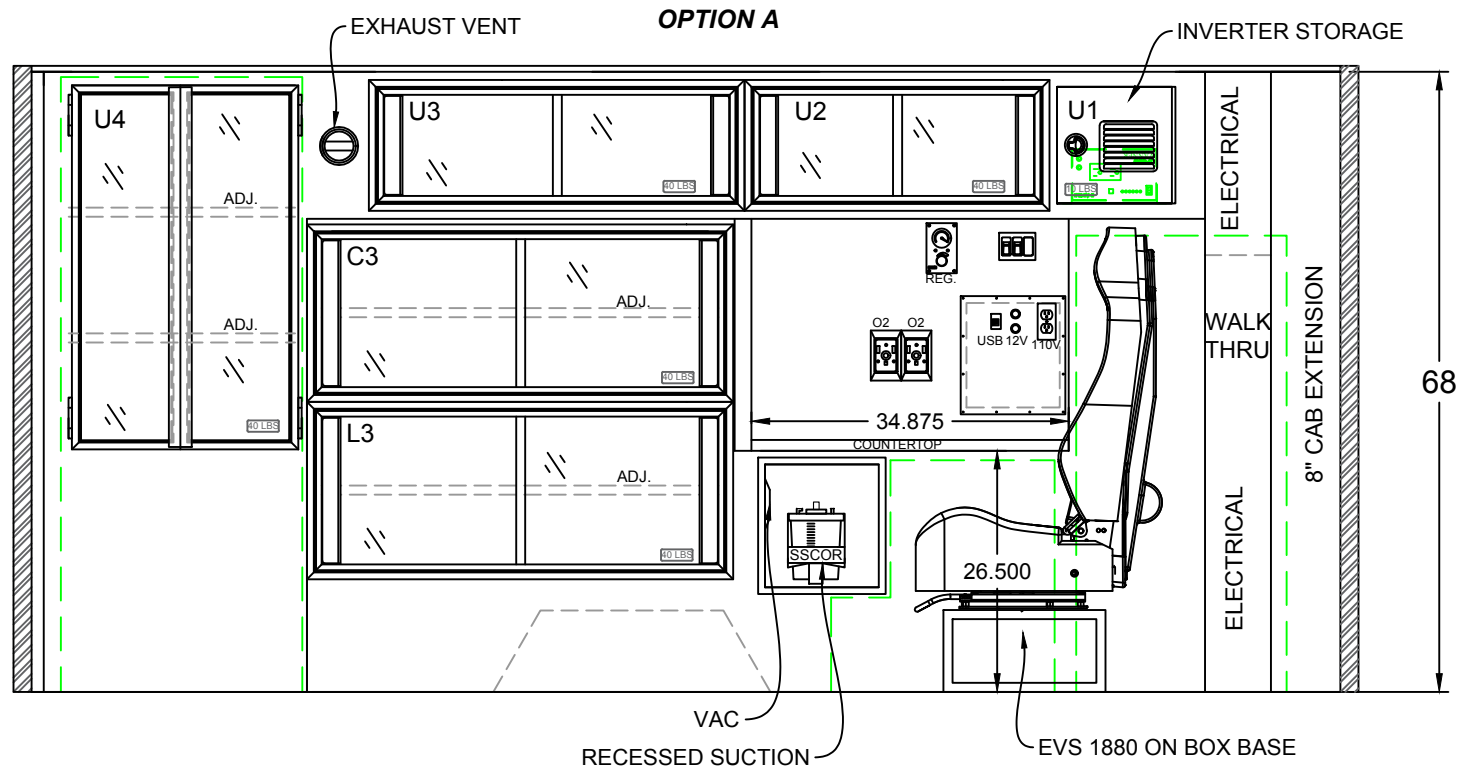

INTERIOR CABINET DIMENSIONS IN INCHES

CABINET	HEIGHT	WIDTH	DEPTH		CABINET	HEIGHT	WIDTH	DEPTH	
U4	40.00	24.75	7.00		L3	18.00	45.25	16.00	
U3	12.75	39.75	16.00						
U2	12.75	32.00	13.75						
U1	13.50	13.00	13.75						
C3.5	18.00	45.25	16.00						



E-350 TYPE 3 FORD 2021

LEFT INTERIOR

49" AISLE

BE ADVISED THAT THESE ARE PRELIMINARY LAYOUTS INTENDED TO ILLUSTRATE DESIGN INTENT AND DIMENSIONS ARE FOR REFERENCE ONLY PRIOR TO FINAL ENGINEERING

DATE:	1/20/21	SCALE:	
DWN BY:	AP	DWG NO:	7 / 12

CA101242

MODEL 3148F CITIMEDIC

148 x 90 x 68

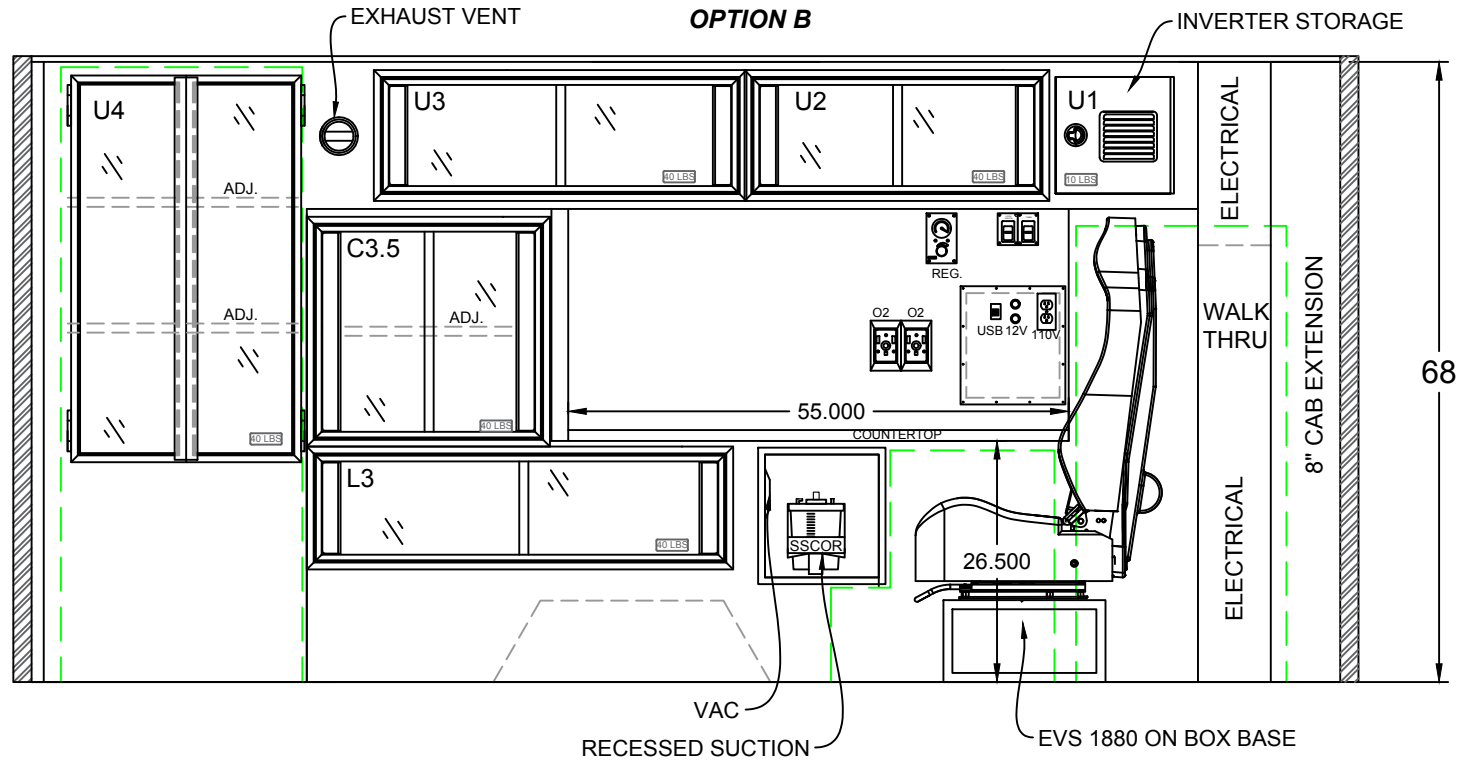

INTERIOR CABINET DIMENSIONS IN INCHES

CABINET	HEIGHT	WIDTH	DEPTH		CABINET	HEIGHT	WIDTH	DEPTH	
J	40.00	24.75	7.00		O	12.00	45.25	16.00	
K	12.75	39.75	16.00						
L1	12.75	32.00	13.75						
L2	13.50	13.00	13.75						
M	23.75	25.25	16.00						



E-350 TYPE 3 FORD 2021
LEFT INTERIOR

DATE: 1/20/21 SCALE:
DWN BY: AP DWG NO: 8 / 12

49" AISLE

BE ADVISED THAT THESE ARE PRELIMINARY LAYOUTS INTENDED TO ILLUSTRATE DESIGN INTENT AND DIMENSIONS ARE FOR REFERENCE ONLY PRIOR TO FINAL ENGINEERING

CA101242

MODEL 3148F CITIMEDIC

148 x 90 x 68

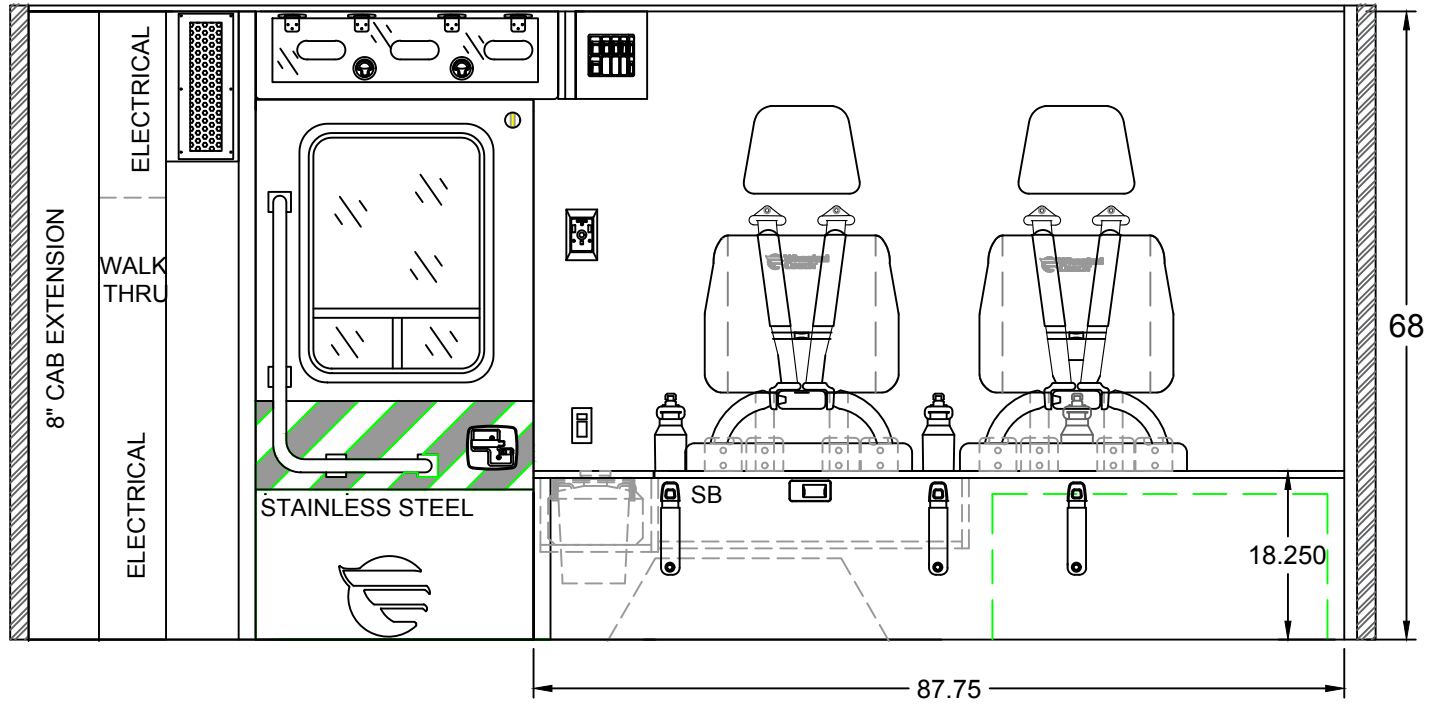

INTERIOR CABINET DIMENSIONS IN INCHES

COMPT.	HEIGHT	WIDTH	DEPTH		COMPT.	HEIGHT	WIDTH	DEPTH	
SB	6.75	30.75	16.00						

49" AISLE

BE ADVISED THAT THESE ARE PRELIMINARY LAYOUTS INTENDED TO ILLUSTRATE DESIGN INTENT AND DIMENSIONS ARE FOR REFERENCE ONLY PRIOR TO FINAL ENGINEERING



E-350 TYPE 3 FORD 2021
RIGHT INTERIOR

DATE:	1/20/21	SCALE:	
DRAWN BY:	AP	DWG NO:	9 / 12

CA101242

MODEL 3148F CITIMEDIC

148 x 90 x 68

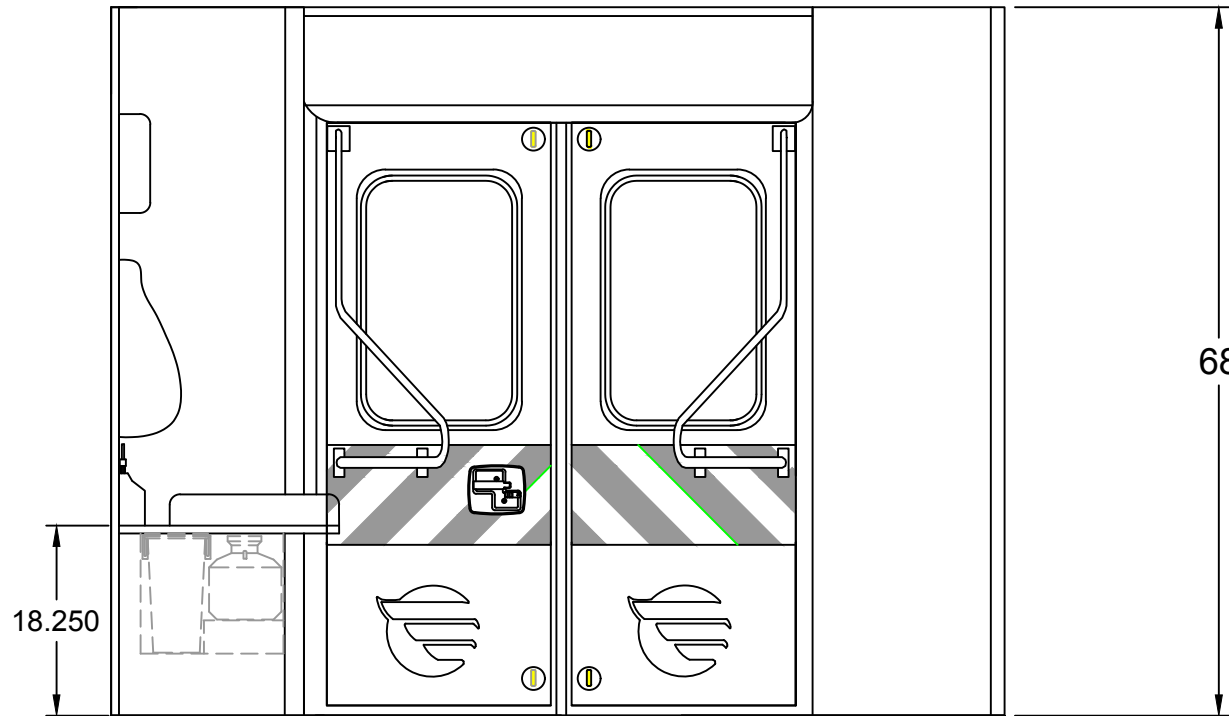

INTERIOR CABINET DIMENSIONS IN INCHES

COMPT.	HEIGHT	WIDTH	DEPTH		COMPT.	HEIGHT	WIDTH	DEPTH	
R1/R2	21.25	13.25	9.00						

49" AISLE

BE ADVISED THAT THESE ARE PRELIMINARY LAYOUTS INTENDED TO ILLUSTRATE DESIGN INTENT AND DIMENSIONS ARE FOR REFERENCE ONLY PRIOR TO FINAL ENGINEERING



E-350 TYPE 3 FORD 2021

REAR BULKHEAD INTERIOR

DATE: 1/20/21 SCALE

DWGN BY: AP DWG NO: 10 12

CA101242

MODEL 3148F CITIMEDIC

148 x 90 x 68

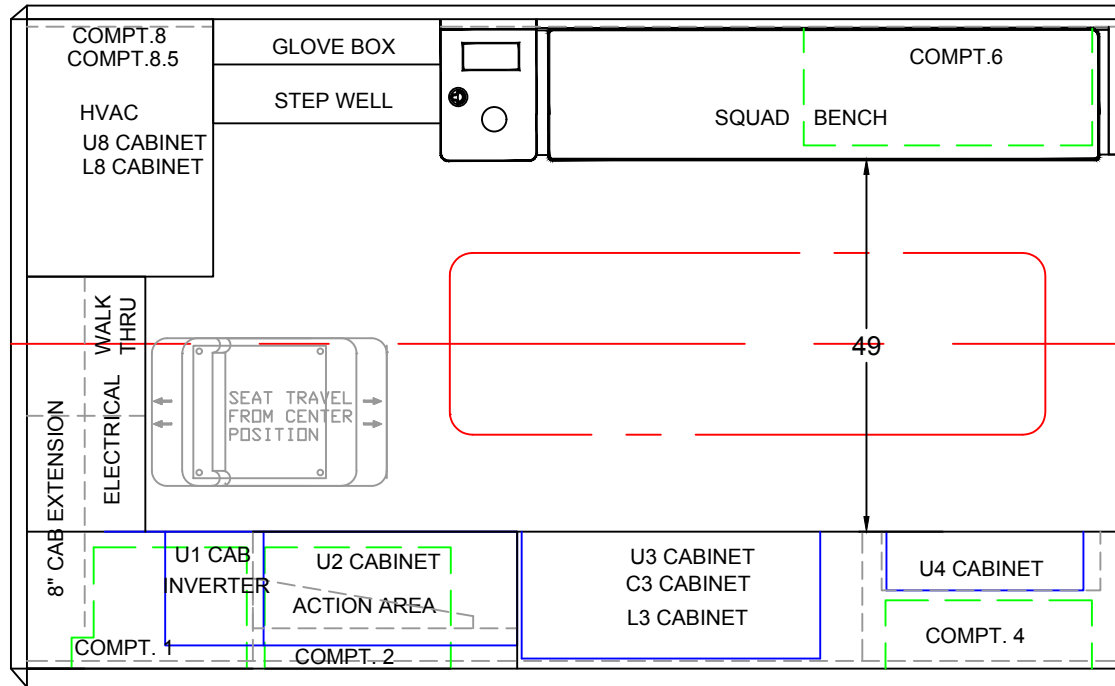

BE ADVISED THAT THESE ARE PRELIMINARY LAYOUTS INTENDED TO ILLUSTRATE DESIGN INTENT AND DIMENSIONS ARE FOR REFERENCE ONLY PRIOR TO FINAL ENGINEERING

INTERIOR CABINET DIMENSIONS IN INCHES

CABINET	HEIGHT	WIDTH	DEPTH	CABINET	HEIGHT	WIDTH	DEPTH



E-350 TYPE 3 FORD 2021
FLOOR PLAN

DATE:	1/20/21	SCALE:	
DWN BY:	AP	DWG NO:	11/12

49" AISLE

CA101242

MODEL 3148F CITIMEDIC

148 x 90 x 68

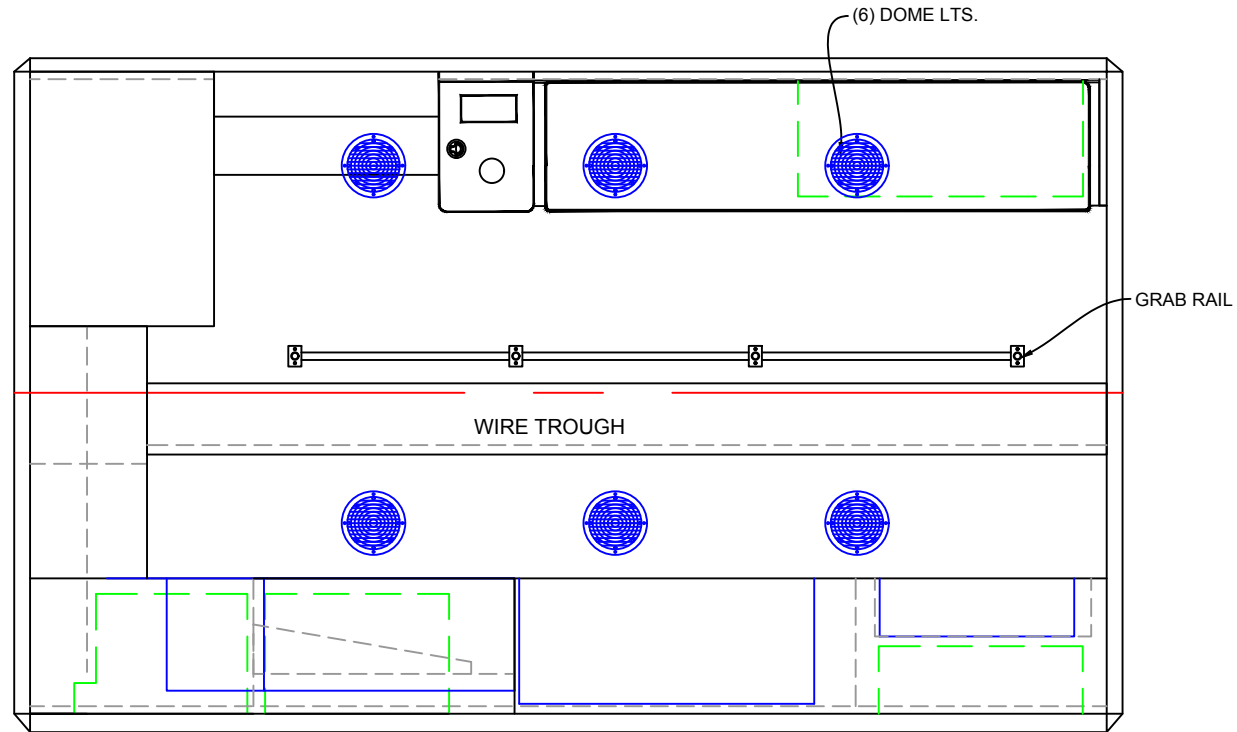

BE ADVISED THAT THESE ARE PRELIMINARY LAYOUTS INTENDED TO ILLUSTRATE DESIGN INTENT AND DIMENSIONS ARE FOR REFERENCE ONLY PRIOR TO FINAL ENGINEERING

INTERIOR CABINET DIMENSIONS IN INCHES

CABINET	HEIGHT	WIDTH	DEPTH	CABINET	HEIGHT	WIDTH	DEPTH



E-350 TYPE 3 FORD 2021

LINER

DATE:	1/20/21	SCALE:	
DWN BY:	AP	DWG NO:	12 12

49" AISLE