

CA101339

MODEL 1148D

148 x 90 x 68

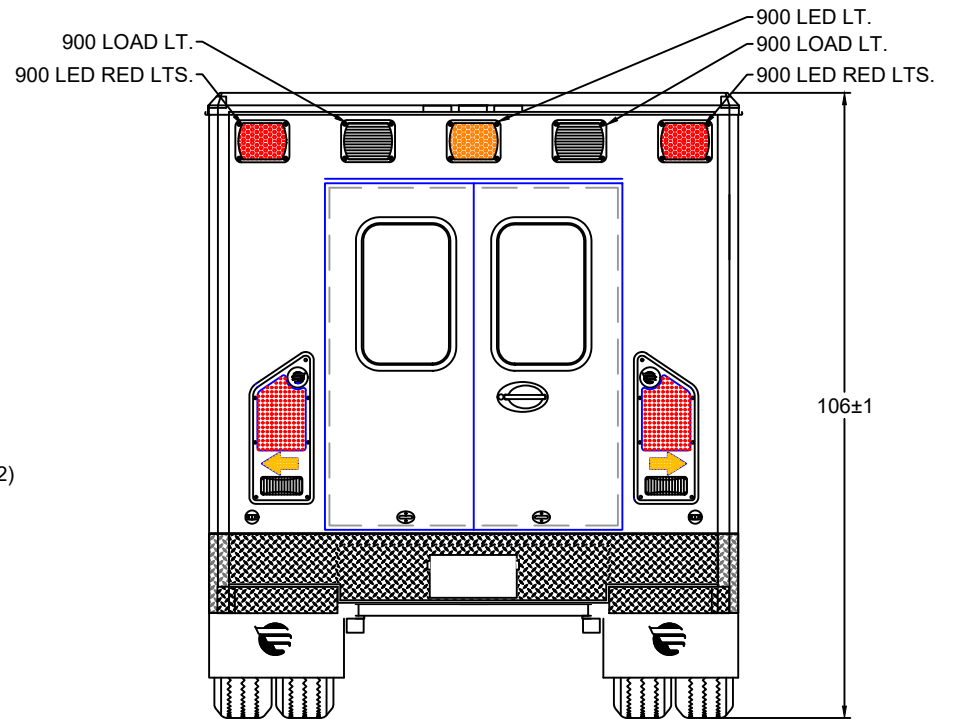
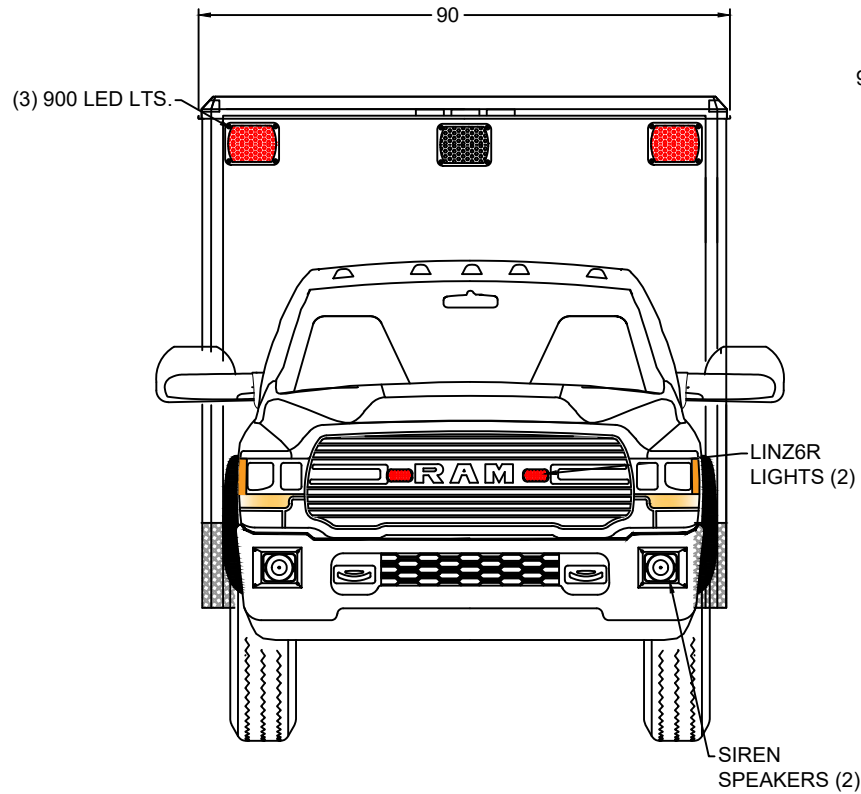

EXTERIOR COMPARTMENT DIMENSIONS IN INCHES

INTERIOR DIMENSIONS				PASS THRU		INTERIOR DIMENSIONS				JAMB OPENING	
COMPT.	HEIGHT	WIDTH	DEPTH	HEIGHT	WIDTH	COMPT.	HEIGHT	WIDTH	DEPTH	HEIGHT	WIDTH



TYPE 1 DODGE 2021  
FRONT / REAR  
EXTERIOR VIEWS

BE ADVISED THAT THESE ARE PRELIMINARY LAYOUTS INTENDED TO ILLUSTRATE DESIGN INTENT AND DIMENSIONS ARE FOR REFERENCE ONLY PRIOR TO FINAL ENGINEERING

DATE: 2/10/21

SCALE

DWN BY AP

DWG NO 1 / 12

49" AISLE

CA101339

MODEL 1148D

148 x 90 x 68

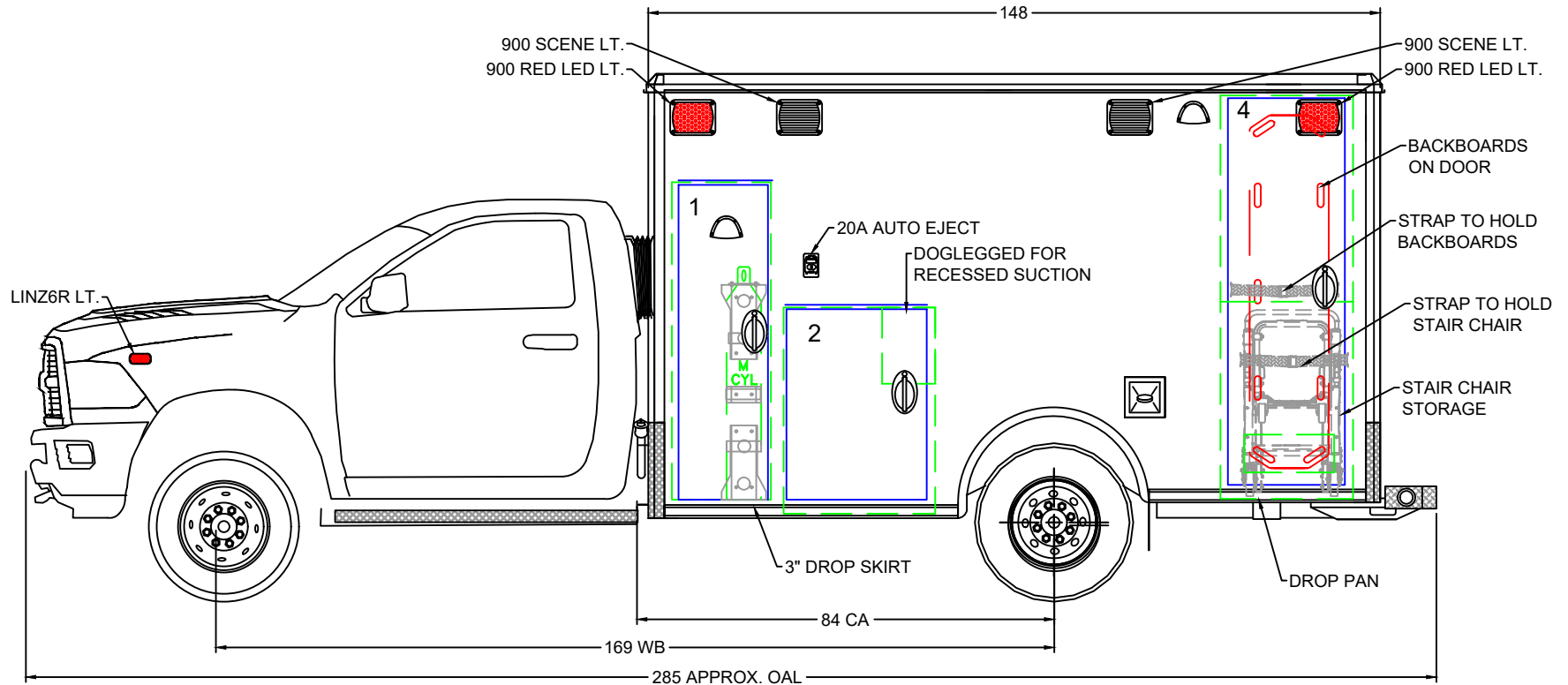

BE ADVISED THAT THESE ARE PRELIMINARY LAYOUTS INTENDED TO ILLUSTRATE DESIGN INTENT AND DIMENSIONS ARE FOR REFERENCE ONLY PRIOR TO FINAL ENGINEERING

EXTERIOR COMPARTMENT DIMENSIONS IN INCHES												
INTERIOR DIMENSIONS				JAMB OPENING		INTERIOR DIMENSIONS				JAMB OPENING		
COMPT.	HEIGHT	WIDTH	DEPTH	HEIGHT	WIDTH	COMPT.	HEIGHT	WIDTH	DEPTH	HEIGHT	WIDTH	
1	64.00	20.00	15.00	63.50	18.00							
2	41.75	30.50	15.00	38.75	28.25							
4	82.50	26.75	8.00	77.75	23.50							
49" AISLE												<small>DATE</small> 2/10/21 <small>SCALE</small> <small>DRAWN BY</small> AP <small>DWG NO</small> 2 / 12

CA101339

MODEL 1148D

148 x 90 x 68

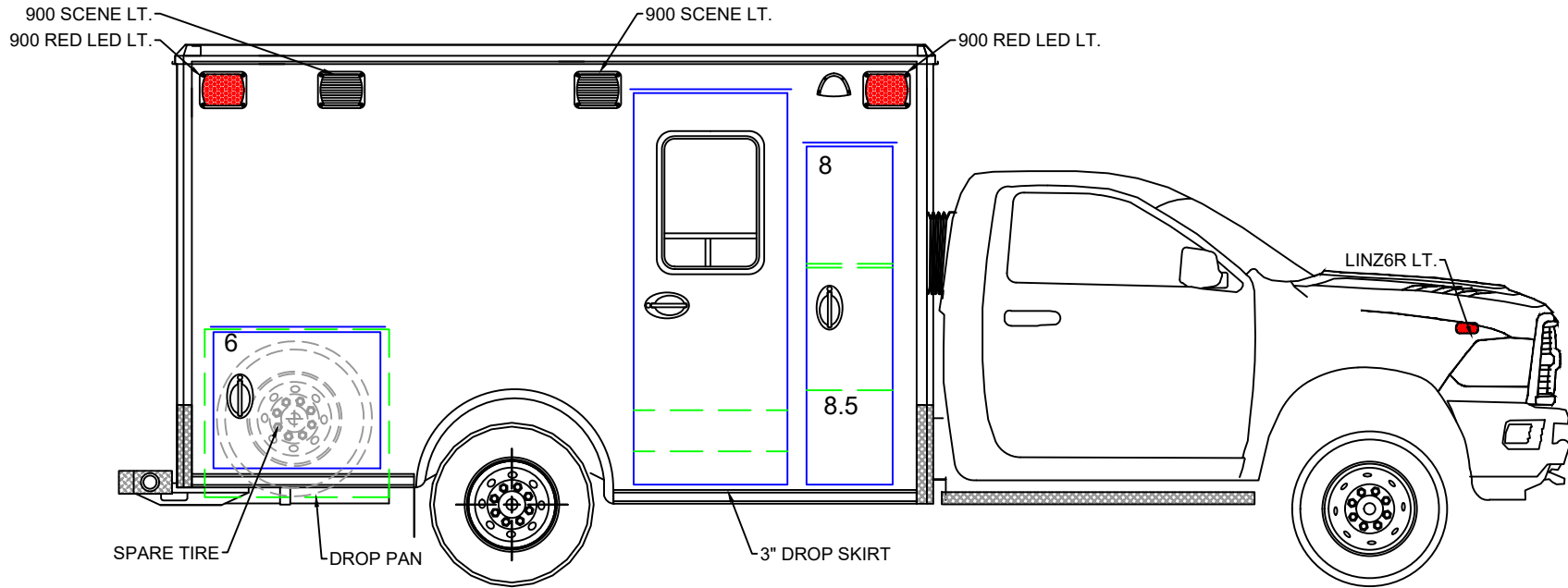

BE ADVISED THAT THESE ARE PRELIMINARY LAYOUTS INTENDED TO ILLUSTRATE DESIGN INTENT AND DIMENSIONS ARE FOR REFERENCE ONLY PRIOR TO FINAL ENGINEERING

EXTERIOR COMPARTMENT DIMENSIONS IN INCHES

INTERIOR DIMENSIONS				JAMB OPENING		INTERIOR DIMENSIONS				JAMB OPENING	
COMPT.	HEIGHT	WIDTH	DEPTH	HEIGHT	WIDTH	COMPT.	HEIGHT	WIDTH	DEPTH	HEIGHT	WIDTH
8				64.75	16.75						
8.5	18.50	19.00	18.75								
6	32.75	38.00	15.50	26.75	34.50						



TYPE 1 DODGE 2021

RIGHT EXT. VIEW

DATE 2/10/21

SCALE

DRAWN BY AP

DWG NO 3 / 12

49" AISLE

CA101339

MODEL 1148D

148 x 90 x 68

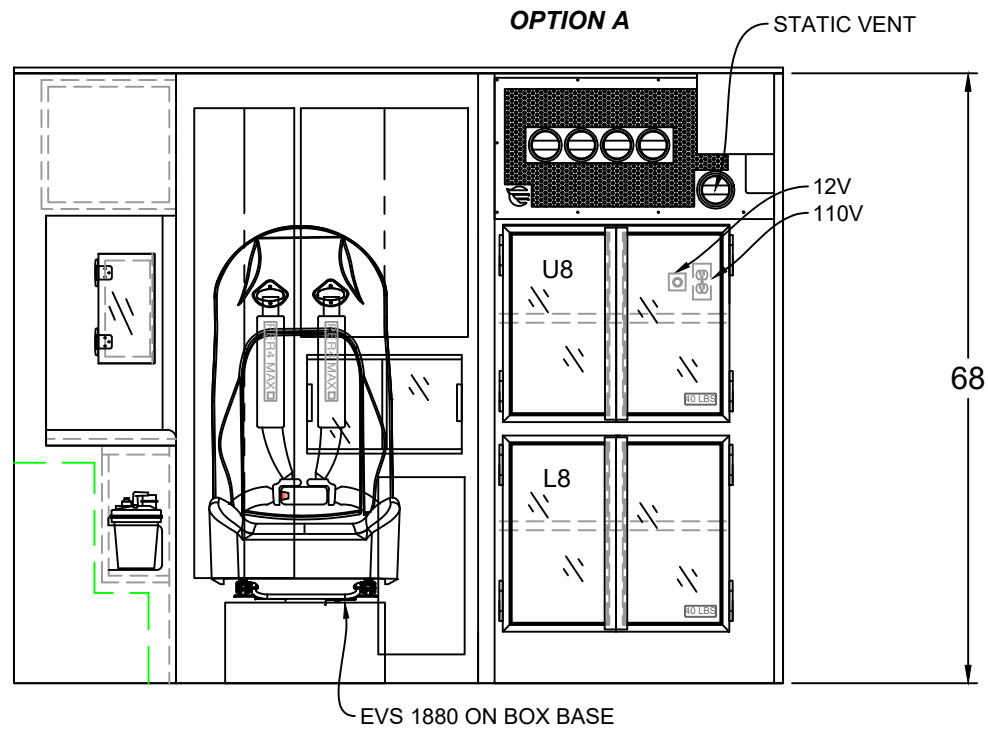

BE ADVISED THAT THESE ARE PRELIMINARY LAYOUTS INTENDED TO ILLUSTRATE DESIGN INTENT AND DIMENSIONS ARE FOR REFERENCE ONLY PRIOR TO FINAL ENGINEERING

<p>CABINET WEIGHT RATINGS: RESTOCKING = 30 LBS. NON-RESTOCKING = 40 LBS.</p>	INTERIOR CABINET DIMENSIONS IN INCHES								 TYPE 1 DODGE 2021 BULKHEAD INTERIOR
	CABINET	HEIGHT	WIDTH	DEPTH	CABINET	HEIGHT	WIDTH	DEPTH	
	U8	22.50	31.50	19.75					
	L8	22.50	31.50	19.75					
								DATE 2/10/21	SCALE
								DRAWN BY AP	DWG NO 4 / 12

49" AISLE

CA101339

MODEL 1148D

148 x 90 x 68

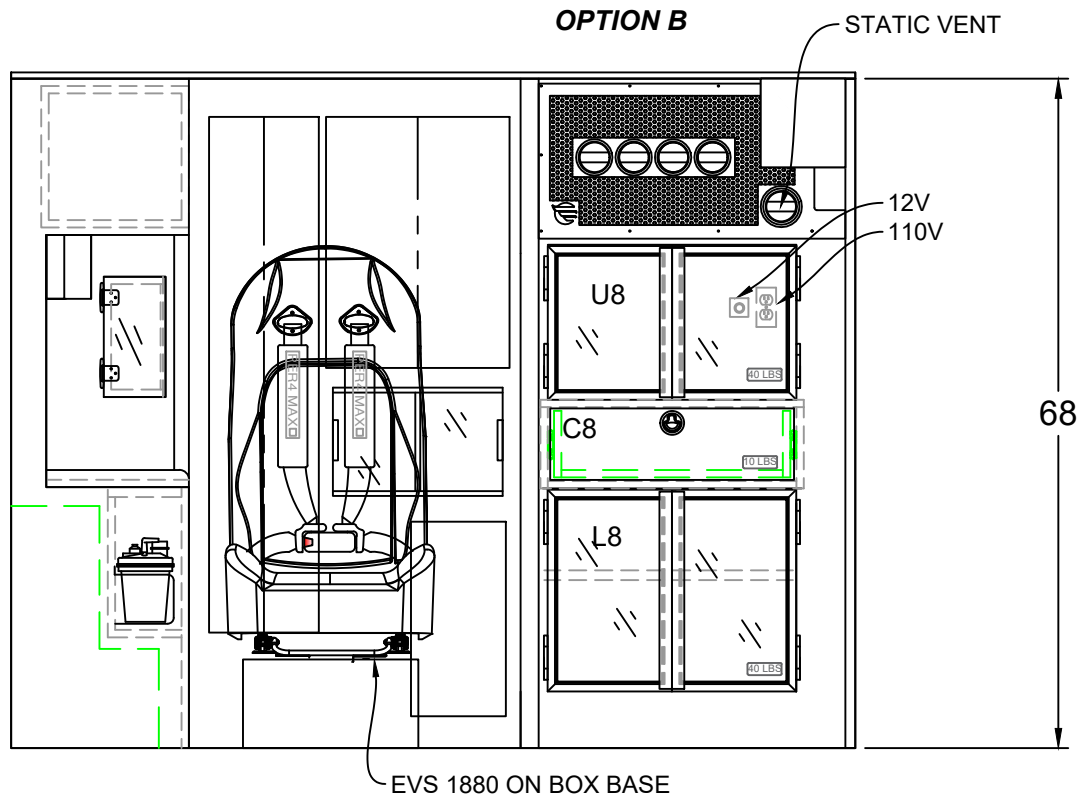

EVS 1880 ON BOX BASE

BE ADVISED THAT THESE ARE PRELIMINARY LAYOUTS INTENDED TO ILLUSTRATE DESIGN INTENT AND DIMENSIONS ARE FOR REFERENCE ONLY PRIOR TO FINAL ENGINEERING

<p>CABINET WEIGHT RATINGS:                  RESTOCKING = 30 LBS.                  NON-RESTOCKING = 40 LBS.</p>	INTERIOR CABINET DIMENSIONS IN INCHES								 TYPE 1 DODGE 2021 BULKHEAD INTERIOR
	CABINET	HEIGHT	WIDTH	DEPTH	CABINET	HEIGHT	WIDTH	DEPTH	
	U8	15.00	31.50	19.75					
	C8	6.00	22.50	18.25					
	L8	20.50	31.50	19.75					
								DATE 2/10/21	SCALE
								DRAWN BY AP	DWG NO 5 / 12

49" AISLE

CA101339

MODEL 1148D

148 x 90 x 68

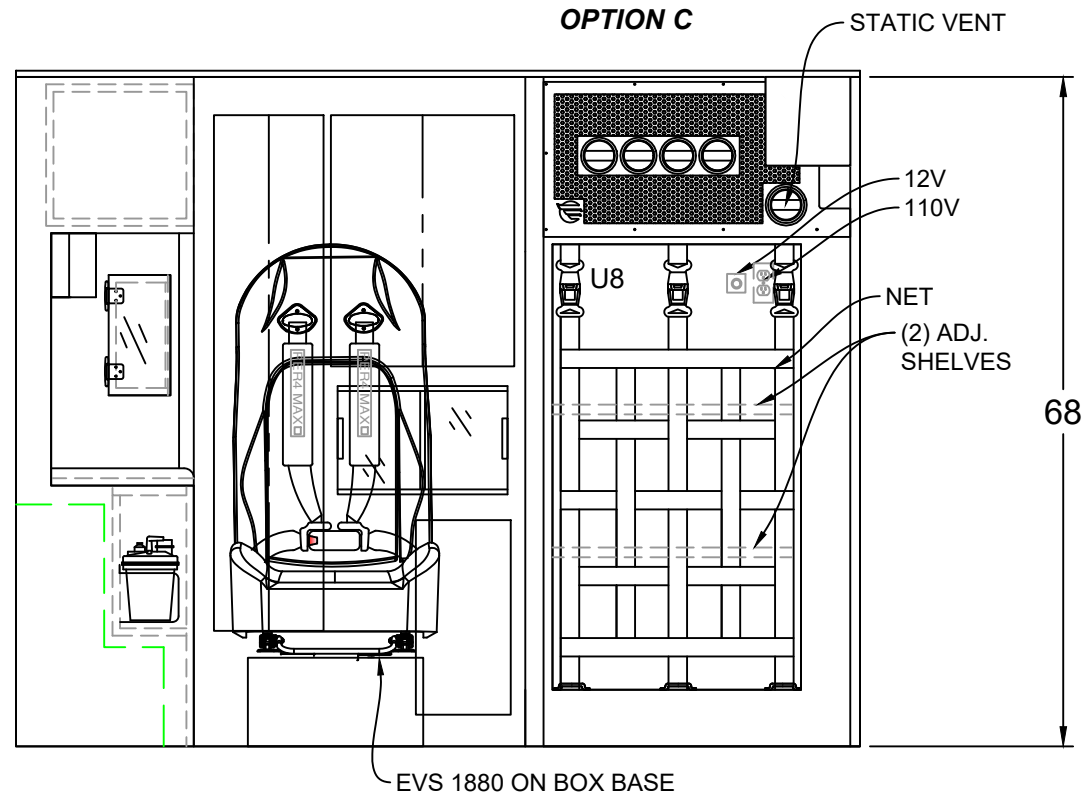

BE ADVISED THAT THESE ARE PRELIMINARY LAYOUTS INTENDED TO ILLUSTRATE DESIGN INTENT AND DIMENSIONS ARE FOR REFERENCE ONLY PRIOR TO FINAL ENGINEERING

<p><u>CABINET WEIGHT RATINGS:</u>                  RESTOCKING = 30 LBS.                  NON-RESTOCKING = 40 LBS.</p>	INTERIOR CABINET DIMENSIONS IN INCHES								 TYPE 1 DODGE 2021 BULKHEAD INTERIOR
	CABINET	HEIGHT	WIDTH	DEPTH	CABINET	HEIGHT	WIDTH	DEPTH	
	U8	46.00	31.50	19.75					
								DATE 2/10/21	SCALE
								DRAWN BY AP	DWG NO 6 / 12

49" AISLE

CA101339

MODEL 1148D

148 x 90 x 68

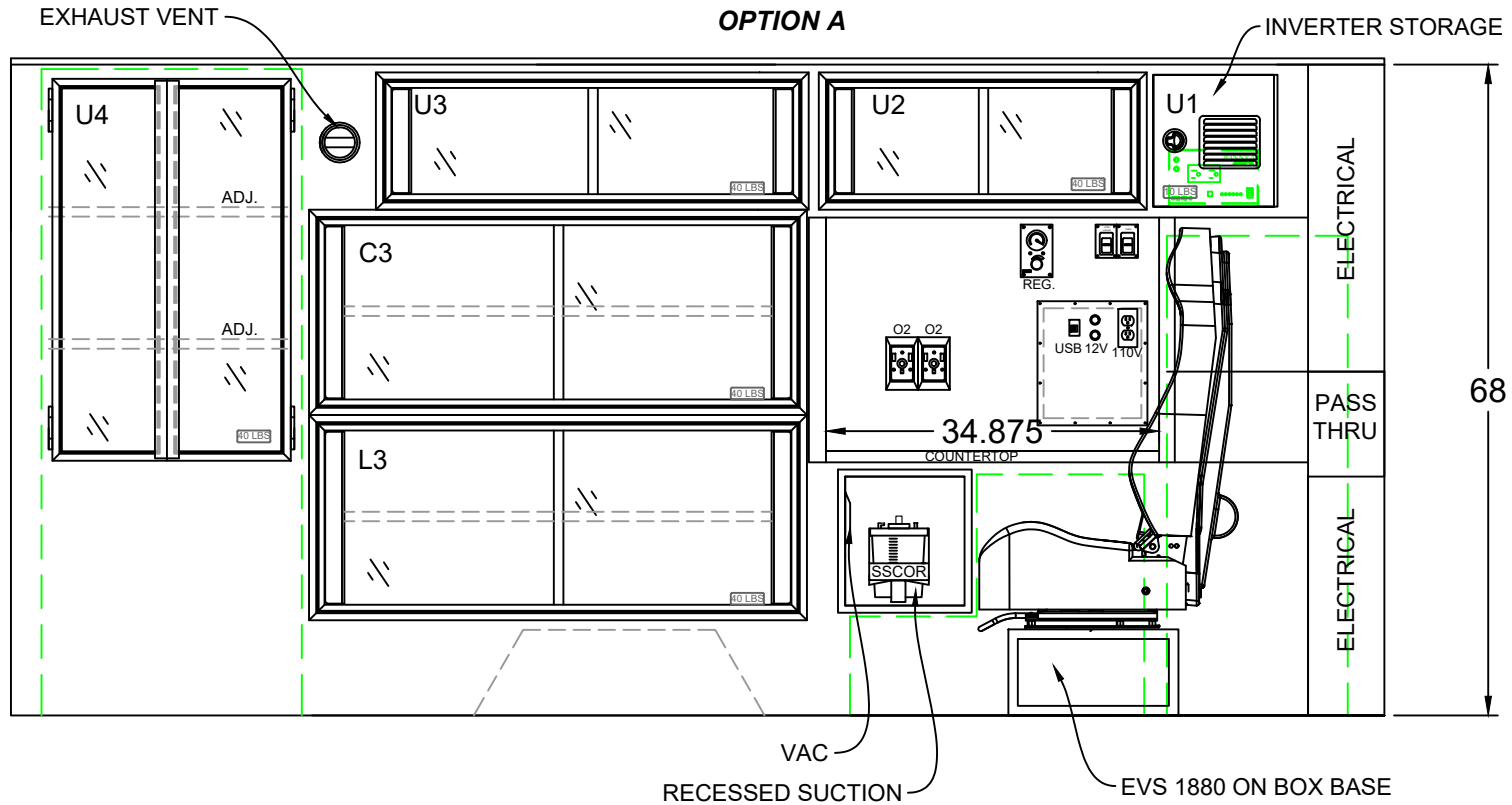

INTERIOR CABINET DIMENSIONS IN INCHES

CABINET	HEIGHT	WIDTH	DEPTH		CABINET	HEIGHT	WIDTH	DEPTH	
U4	40.00	24.75	7.00		L3	20.00	50.50	16.00	
U3	12.75	43.75	16.00						
U2	12.75	32.75	13.75						
U1	13.50	13.00	13.75						
C3	20.00	50.50	16.00						



TYPE 1 DODGE 2021

LEFT INTERIOR

DATE:	2/10/21	SCALE:	
DWN BY:	AP	DWG NO:	7 / 12

49" AISLE

**CABINET WEIGHT RATINGS:**  
 RESTOCKING = 30 LBS.  
 NON-RESTOCKING = 40 LBS.

BE ADVISED THAT THESE ARE PRELIMINARY LAYOUTS INTENDED TO ILLUSTRATE DESIGN INTENT AND DIMENSIONS ARE FOR REFERENCE ONLY PRIOR TO FINAL ENGINEERING

CA101339

MODEL 1148D

148 x 90 x 68

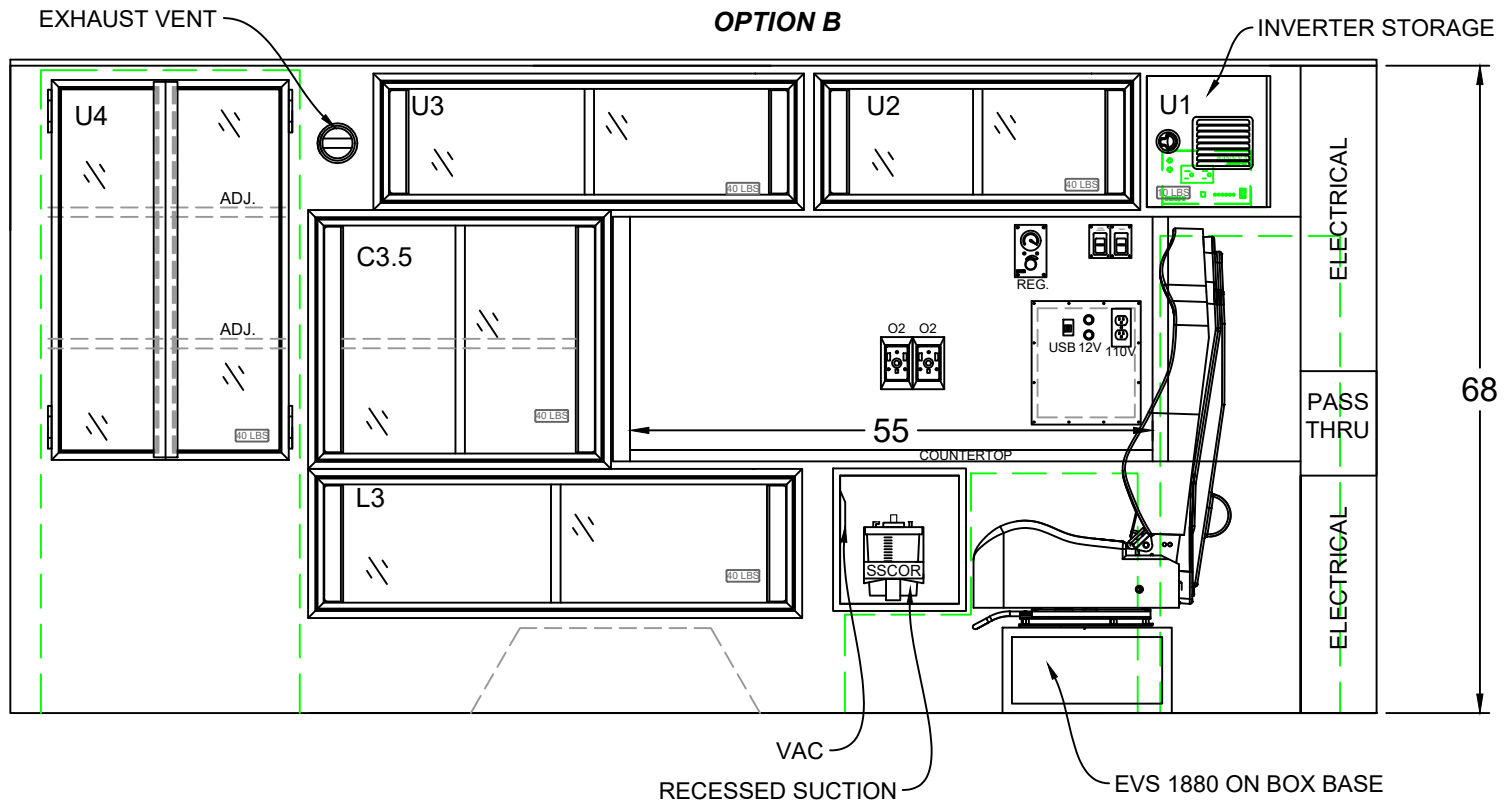

INTERIOR CABINET DIMENSIONS IN INCHES

CABINET	HEIGHT	WIDTH	DEPTH		CABINET	HEIGHT	WIDTH	DEPTH	
U4	40.00	24.75	7.00		L3	14.25	50.50	16.00	
U3	12.75	43.75	16.00						
U2	12.75	32.75	13.75						
U1	13.50	13.00	13.75						
C3.5	25.75	30.25	16.00						



TYPE 1 DODGE 2021

LEFT INTERIOR

DATE:	2/10/21	SCALE:	
DWN BY:	AP	DWG NO:	8 / 12

49" AISLE

**CABINET WEIGHT RATINGS:**  
 RESTOCKING = 30 LBS.  
 NON-RESTOCKING = 40 LBS.

BE ADVISED THAT THESE ARE PRELIMINARY LAYOUTS INTENDED TO ILLUSTRATE DESIGN INTENT AND DIMENSIONS ARE FOR REFERENCE ONLY PRIOR TO FINAL ENGINEERING



CA101339

MODEL 1148D

148 x 90 x 68

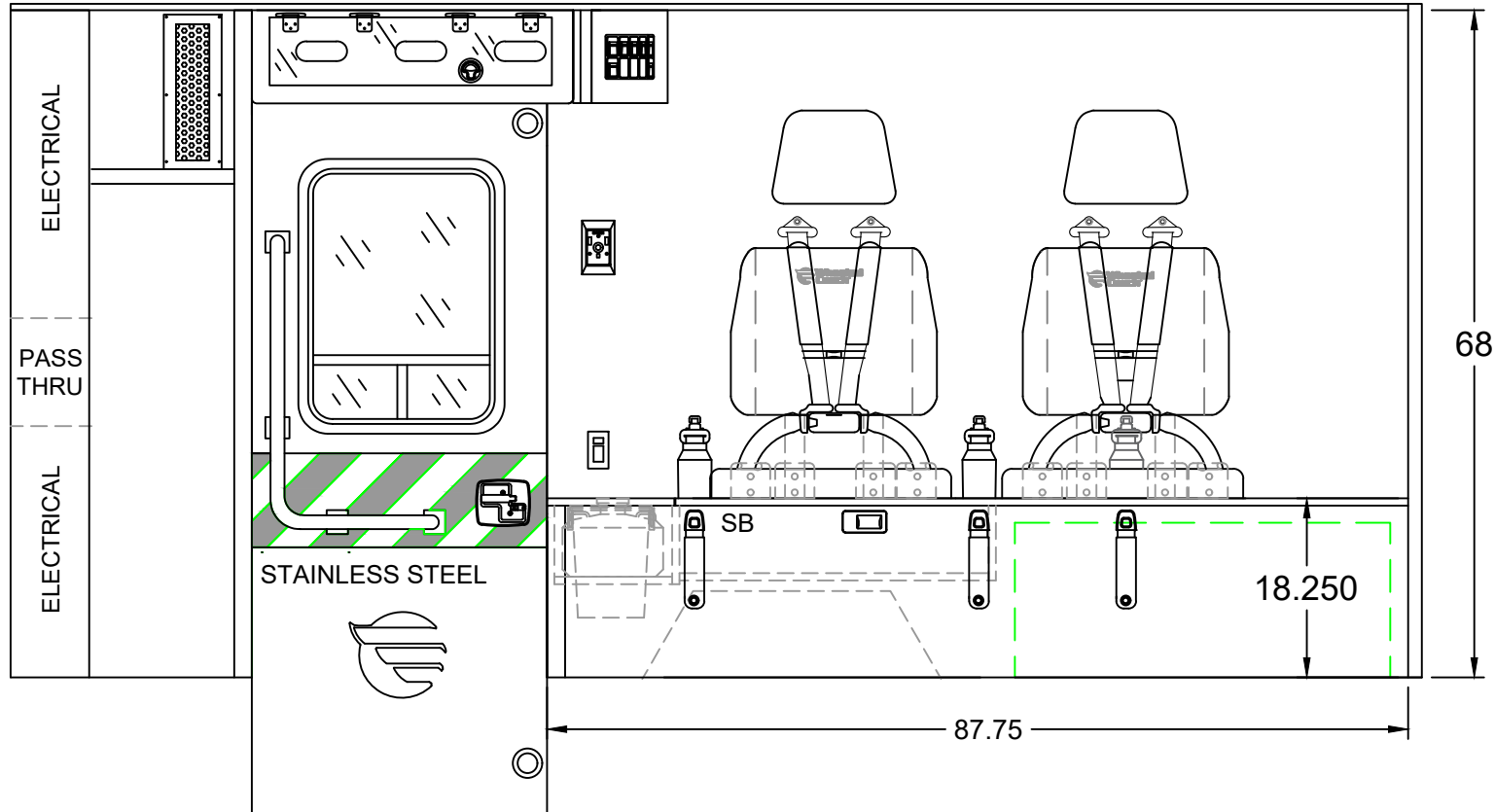

INTERIOR CABINET DIMENSIONS IN INCHES

COMPT.	HEIGHT	WIDTH	DEPTH		COMPT.	HEIGHT	WIDTH	DEPTH	
SB	6.75	30.75	16.00						

49" AISLE

**CABINET WEIGHT RATINGS:**  
 RESTOCKING = 30 LBS.  
 NON-RESTOCKING = 40 LBS.

BE ADVISED THAT THESE ARE PRELIMINARY LAYOUTS INTENDED TO ILLUSTRATE DESIGN INTENT AND DIMENSIONS ARE FOR REFERENCE ONLY PRIOR TO FINAL ENGINEERING



TYPE 1 DODGE 2021  
 RIGHT INTERIOR

DATE:	2/10/21	SCALE:	
DWN BY:	AP	DWG NO:	9 / 12

CA101339

MODEL 1148D

148 x 90 x 68

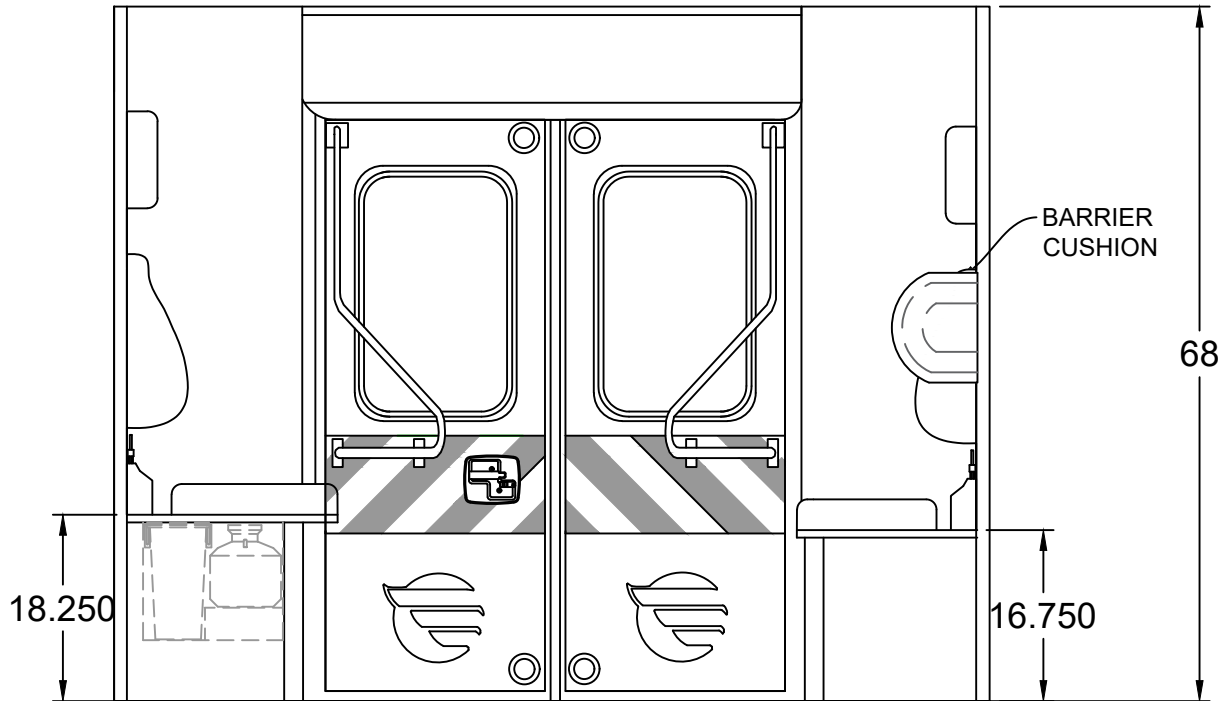

INTERIOR CABINET DIMENSIONS IN INCHES



COMPT.	HEIGHT	WIDTH	DEPTH	COMPT.	HEIGHT	WIDTH	DEPTH

TYPE 1 DODGE 2021  
REAR BULKHEAD INTERIOR

DATE: 2/10/21 SCALE

49" AISLE CABINET WEIGHT RATINGS:  
RESTOCKING = 30 LBS.  
NON-RESTOCKING = 40 LBS.

BE ADVISED THAT THESE ARE PRELIMINARY LAYOUTS INTENDED TO ILLUSTRATE DESIGN INTENT AND DIMENSIONS ARE FOR REFERENCE ONLY PRIOR TO FINAL ENGINEERING

OWN BY AP DWG NO 10 12

CA101339

MODEL 1148D

148 x 90 x 68

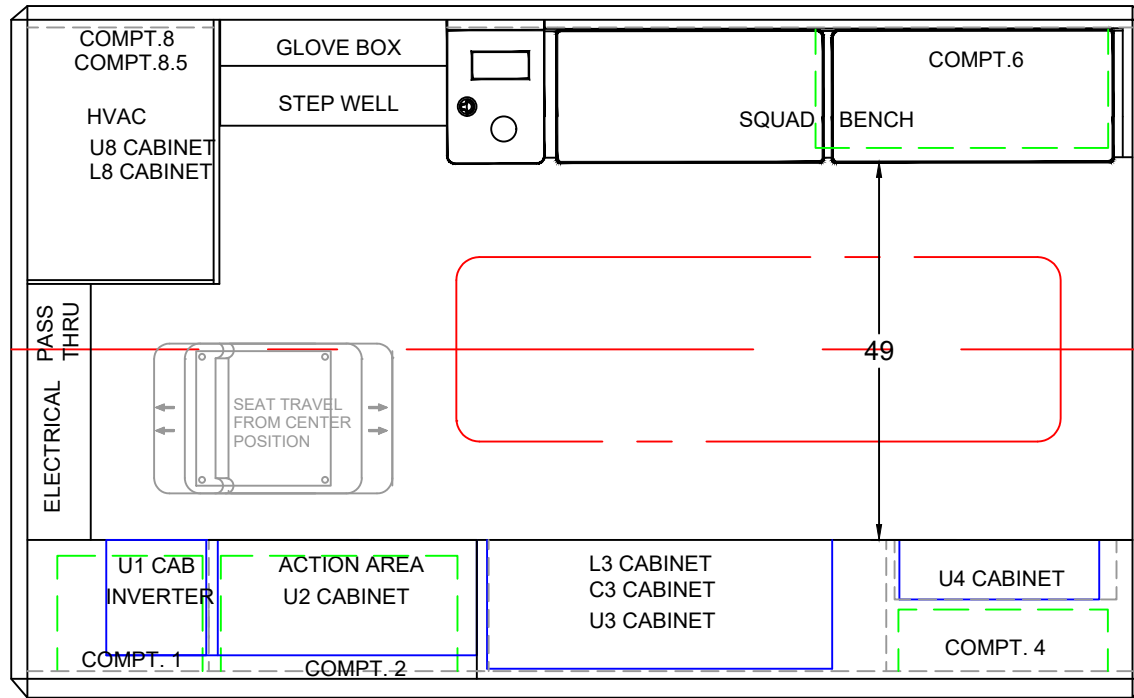

BE ADVISED THAT THESE ARE PRELIMINARY LAYOUTS INTENDED TO ILLUSTRATE DESIGN INTENT AND DIMENSIONS ARE FOR REFERENCE ONLY PRIOR TO FINAL ENGINEERING

INTERIOR CABINET DIMENSIONS IN INCHES

CABINET	HEIGHT	WIDTH	DEPTH	CABINET	HEIGHT	WIDTH	DEPTH



TYPE 1 DODGE 2021  
FLOOR PLAN

DATE:	2/10/21	SCALE:	
DWN BY:	AP	DWG NO:	11/12

49" AISLE

CA101339

MODEL 1148D

148 x 90 x 68

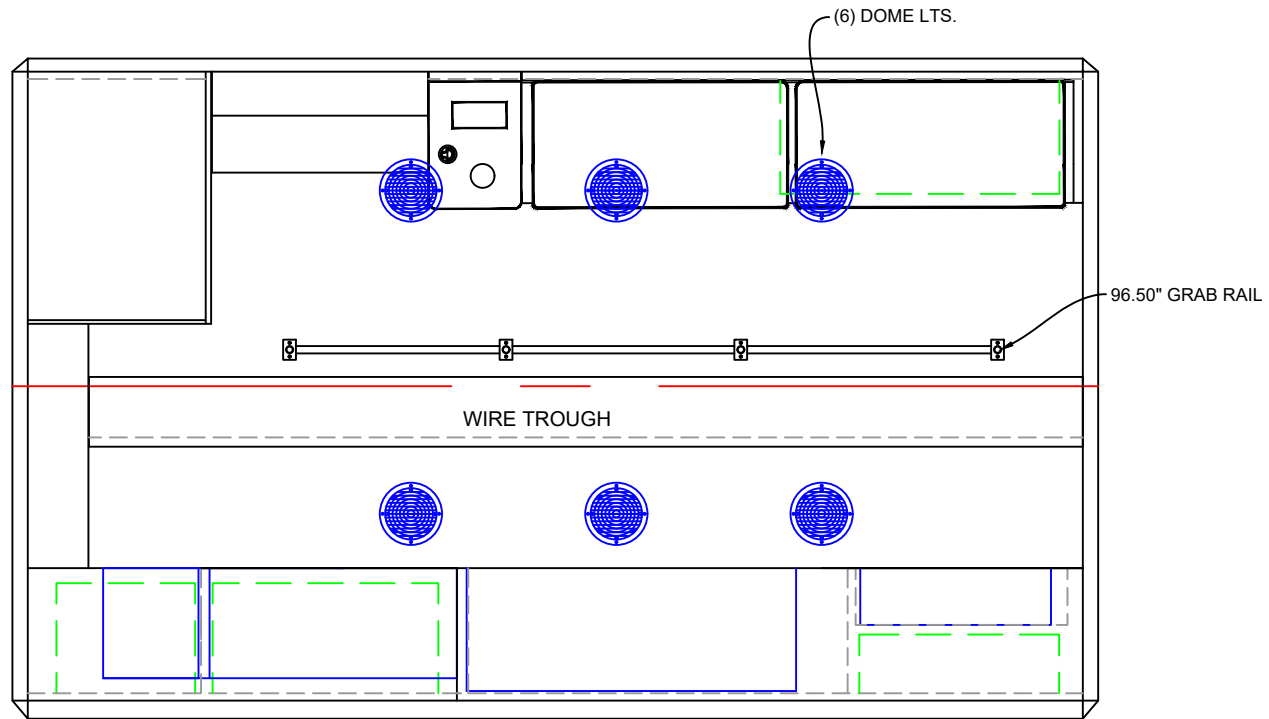

BE ADVISED THAT THESE ARE PRELIMINARY LAYOUTS INTENDED TO ILLUSTRATE DESIGN INTENT AND DIMENSIONS ARE FOR REFERENCE ONLY PRIOR TO FINAL ENGINEERING

INTERIOR CABINET DIMENSIONS IN INCHES								
CABINET	HEIGHT	WIDTH	DEPTH	CABINET	HEIGHT	WIDTH	DEPTH	
								TYPE 1 DODGE 2021 LINER
								DATE: 2/10/21 SCALE
								DWN BY: AP DWG NO: 12 12

49" AISLE